

Model 5518A Mic/Line Interface

User Guide

Issue Preliminary 2, February 2025

This User Guide is applicable for serial numbers
M5518A-00151 and later with Main MCU Firmware 1.01 and later

Copyright © 2025 by Studio Technologies, Inc., all rights reserved
studio-tech.com

This page intentionally left blank.

Table of Contents

Revision History.....	4
Introduction.....	5
Installation	9
ST 2110 Configuration.....	13
Model 5518A Configuration	13
Operation.....	27
Technical Notes	29
Specifications	33
Appendix A–Connection Pin-Out Chart	35
Appendix B–Source Selection Overview	36
Appendix C–Front-Panel Menu Structure.....	37
Appendix D–ZMAN Firmware Update Screen.....	38
Appendix E–Advanced ZMAN General Settings Screens	42
Appendix F–Default Configuration Values.....	43
Appendix G–Accessing the Unit when User Name and/or Password are Not Known	44

Revision History

Issue Preliminary 2, February 2025:

- Documents Secondary MCU
- Miscellaneous edits and corrections.

Issue Preliminary 1, February 2025:

- Initial preliminary release.

Introduction

The Model 5518A Mic/Line Interface provides a simple yet high-performance means of interfacing analog signals with applications that utilize the SMPTE® ST 2110 suite of standards to implement audio-over-Ethernet networking connectivity. Redundant stream performance is supported following the ST 2022-7 standard. The unit is compatible with the SMPTE ST 2110-30 standard for PCM audio signals and the ST 2110-10 standard for signal timing.

Eight analog microphone- or line-level sources can be connected to the unit and then output in the digital domain by way of the Ethernet interfaces. Eight digital audio signals, which arrive by way of Ethernet, are converted to analog and then output as balanced line-level signals. For application troubleshooting, a configuration choice allows 1 kHz tones or the mic/line inputs to be selected as the sources for the analog output channels. A monitor section allows the input and output signals to be selectively observed using a meter function, a headphone output, and, if desired, two line-level analog outputs.

The Model 5518A is a fully professional product that offers the audio quality, features, and reliability required by 24-hour on-air and commercial applications. Located on the unit's front panel, the eight mic/line audio inputs use standard 3-pin female XLR connectors for easy interfacing with balanced and unbalanced sources. The input circuitry features adjustable gain, P48 phantom power, and high-pass filter functions. Configuration of the input channels can be made locally using pushbutton switches and an associated OLED display. Webpages, accessible using the Model 5518A's integrated web server, allow remote control of the input parameters. The analog mic/line input audio signals are converted to 24-bit PCM digital and then transported via the Ethernet network interfaces.

The destination routing of the mic/line input signals can be performed using the Model 5518A's internally provided webpages or JSON API commands. In addition, NMOS and ANEMAN network management can also be utilized.

Digital audio sources associated with ST 2110-compliant devices can be routed to the Model 5518A, converted to analog, and then provided to users as balanced line-level analog outputs. A 25-pin female D-subminiature connector, located on the unit's back panel, provides access to the eight analog outputs. The digital audio sources can be routed to the Model 5518A using internally provided webpages, JSON API commands, or the ANEMAN software application. Configuration tasks can also be performed following the NMOS IS-04 and IS-05 standards.

The monitor section provides the user with the ability to select any input or output signal, or signal pair, for monitoring using the 2-channel (stereo) headphone output. A configuration choice allows selected analog outputs to provide a monitoring function for connection to inputs on amplified loudspeakers or audio power amplifiers. An OLED display, located on the unit's front panel, offers a metering function which allows the input and output audio signals to be visually monitored.

The Model 5518A provides three Gigabit Ethernet (GigE) network interfaces, two to support redundant operation following the ST 2022-7 standard and the third for accessing the management menu system. An internal web server allows fast and flexible monitoring and configuration of the unit's audio input and output performance. Front-panel indicators, an OLED display, and pushbutton switches provide users with direct access to key operating parameters.

The Model 5518A can be powered by 100-240 V, 50/60 Hz mains or a source of 12 volts DC. Both can be simultaneously connected to provide redundant



Figure 1. Model 5518A Mic/Line Interface front view

operation. The lightweight enclosure mounts in one space (1U) of a standard 19-inch rack. Industry-standard connectors are used for the audio input, audio output, Ethernet, AC mains, and DC power interconnections.

Audio over Managed IP Networks

Digital audio data associated with the Model 5518A is interfaced with local area network (LAN) connections following the SMPTE ST 2110 standards. A highlight of ST 2110 is its ability to utilize any standard Ethernet network implementation, including switches, to directly transport professional audio signals. For signal integrity the Model 5518A supports redundant audio data streams per the ST 2022-7 standard. The unit supports digital audio signals with a sampling rate of 48 kHz and a bit depth of 24. This ensures compatibility with virtually all broadcast, production, industrial, and commercial applications.

Network Interfaces

The Model 5518A's Primary + Control and Secondary Ethernet interfaces can be utilized for 2022-7 Redundant Stream applications. The third Ethernet interface, named MGMT (Management), will always be used to access the unit's management webpages. This interface can be connected to an independent network that some facilities implement for equipment monitoring and maintenance purposes. The unit's management web server can also be connected to the network that is being used for ST 2110 operation. This would function correctly since the management web server will always have a unique IP address that would not interact with audio and related data. Status LEDs, located on the unit's back panel, provide a real-time indication of LAN performance.

Applications

The Model 5518A is a general-purpose mic/line input, analog output, and monitoring device intended for a variety of audio and audio-for-picture applications that utilize the ST 2110 suite of standards. It's suitable for use in demanding on-air broadcast and live-event

applications that require both excellent audio performance and reliable operation. The rack-mounted unit is appropriate for installation in fixed locations, serving the needs of systems associated with post-production, content distribution, education, commercial, and government facilities. Its lightweight enclosure also makes it suitable for mobile and field uses.

The Model 5518A features an optimized set of controls and indicators that makes it simple and intuitive to use. With the unit's headphone and level monitoring resources it's easy for operators to obtain optimal performance. By providing standard connectors for all inputs and outputs, operating changes can be completed simply and rapidly.

ST 2110 Networking

ST 2110 is an emerging technology that is finding wide acceptance as an audio, video, and ancillary data transport "backbone" due to its interoperability, flexibility, and support by a large number of equipment manufacturers. The Model 5518A can serve as an "edge" device for ST 2110-compliant implementations, providing high-performance input, output, and monitor resources in a compact, cost-effective package. The unit can also serve as a general-purpose audio "tool" to help extend ST 2110 capabilities to facilities and applications that were initially implemented to support signals in the analog domain.

The Model 5518A's ST 2110 interface supports conformance levels A, B, C, AX, BX, and CX in single and redundant streams. The latter follows the SMPTE ST 2022-7 standard and allows connection of one or two networks as desired. The Primary + Control Ethernet interface allows configuration of the ST 2110 interface by way of webpages. NMOS support that follows the IS-04 and IS-05 standards is provided. The Merging Technologies ANEMAN Audio Network Manager application can also be utilized as can a JSON API. The ST 2110 audio sample rate is selected for 48 kHz with a bit depth of 24.



Figure 2. Model 5518A Mic/Line Interface back view

Studio Technologies has not fully explored the Model 5518A's ability to support Ravenna and AES67. The ST 2110 capabilities in the Model 5518A are provided by the ZMAN module from Merging Technologies. The ZMAN specifications indicate full compatibility with Ravenna and AES67. As such, Model 5518A ST 2110 audio channels should be directly compatible with AES67 audio channels. (Actually, our impression is that ST 2110 audio was based on ensuring compatibility with AES67.) Ravenna is also, depending on its configuration, directly compatible with AES67. So, in theory, the Model 5518A can serve both as a Ravenna to Dante and a AES67 to Dante bridge. Settings in the ZMAN-provided configuration webpages may have to be selected specifically for compatibility with Ravenna or AES67, but the required parameters should be able to be selected. Over time Studio Technologies will explore this subject further and a conversation with factory personnel may provide additional clarity.

Mic/Line Inputs

The Model 5518A provides eight analog inputs that are compatible with microphone and line-level signals. The mic/line input circuitry allows the level of the connected sources to be boosted as required, converted to digital, and then output as part of an IP stream via an Ethernet network. Each mic/line input can be individually configured to meet the requirements posed by a wide range of sources. The configuration choices can be made either locally or by way of webpages associated with an internal web server. The preamplifier of each channel can be selected for 0 dB of gain to support line-level sources or 10 to 60 dB of gain, in 1-dB steps, for microphones. A source of P48 phantom power can be enabled to power condenser microphones. In addition, a high-pass filter (HPF) function can be enabled as required to reduce the presence of unwanted low-frequency content typically associated with hum, rumble, or wind noise.

Compatible signal sources include dynamic, ribbon, and phantom-powered condenser (capacitor) microphones. The preamplifier gain setting of 0 dB and the range of 10 to 20 dB were specifically included to support connection of balanced and unbalanced line-level signals that are commonly provided by professional and semi-professional audio equipment. Typical nominal levels for these sources would be

+4 dBu and -10 dBV, respectively. Devices providing these analog signal sources could include audio consoles, wireless microphone receivers, and broadcast playback equipment.

For front-panel space efficiency the eight mic/line input channels share a common configuration section which includes seven pushbutton switches and an OLED display. The buttons allow rapid local selection of the preamplifier gain as well as controlling the on/off status of the P48 phantom power and high-pass filter (HPF) functions. The OLED display allows the preamplifier gain of each mic/line input channel to be observed. Audio channel level metering is also provided as part of the OLED display's resources. The "virtual" meters can assist users in optimizing the preamplifier gain settings which in turn will provide the best possible conversion from the analog to the digital domain. LED indicators associated with each mic/line input channel provide the on/off status of the P48 phantom power and high-pass filter (HPF) functions.

The mic/line inputs are electronically balanced (differential), capacitor-coupled, and ESD (static) protected for reliable operation in demanding applications. Extensive filtering minimizes the chance that radio frequency (RF) energy will cause interference. The inputs are protected from damage should a moderate DC voltage be accidentally connected. The sum of these characteristics makes the mic/line inputs suitable for use in studio and mobile facilities as well as field-deployed environments.

The eight 3-pin female XLR connectors associated with the Model 5518A's mic/line inputs were specifically located on the front panel. This can eliminate the need for an external I/O or "patch" panel, allowing signal sources and their associated interconnecting cables to be rapidly connected and disconnected as required. Rather than being buried in the back of a rack enclosure, the Model 5518A provides convenient access to the mic/line input connectors and their associated configuration buttons, indicators, and OLED display.

The audio performance of the Model 5518A's mic/line inputs is very good. Low-noise, wide dynamic-range preamplifier circuits ensure that input audio quality is preserved. The P48 phantom power source is extremely low noise, allowing optimal microphone

operation and imparting little signal degradation. The outputs of the preamplifiers are routed to high-performance analog-to-digital conversion (ADC) sections that support a 48 kHz sampling rate and a bit depth of 24. A precision voltage-reference circuit helps the ADC circuitry perform highly accurate signal conversion. The audio signals, now in the digital domain, are packetized and prepared for transport over Ethernet networking.

Analog Outputs

The Model 5518A provides eight general-purpose line-level analog output channels. Each channel can be individually configured to use as its input source a ST 2110-30 receiver (input) channel, a mic/line input channel, one of the monitor output channels, or a 1 kHz sine-wave tone. In most applications, a digital receiver (input) channel associated with the unit's Ethernet interfaces will serve as the audio source. The unit's JSON API or the ANEMAN software application would be used to select the sources which originate from channels on designated ST 2110-compliant equipment.

Another configuration choice allows an analog signal associated with the unit's mic/line inputs to serve as the source for an analog output channel. The selected signal would be post (after) the mic/line input circuitry and provide a broadcast-style "hot mic" line-level analog output version of its associated mic/line input signal. To allow connection to inputs on amplified speakers any analog output channel can also be configured to use either of the two monitor outputs as its source. For troubleshooting purposes, a 1 kHz sine-wave tone can be assigned as the source for any analog output channel. This resulting analog output signal would have a nominal level of +4 dBu.

The Model 5518A's analog outputs have a maximum level of +24 dBu. This allows both compatibility and sufficient headroom in applications where digital audio signals with a nominal level of -20 dBFS need to translate into analog signals that have a nominal level of +4 dBu. For flexibility, a configuration menu choice allows the level of each analog output channel to be individually adjusted ("trimmed") over a range of ± 20 dB in 1-dB steps. This ensures that the Model 5518A will also be compatible in environments that utilize 0, +4, +6, or even +8 dBu nominal output levels.

The analog outputs are electronically balanced, capacitor-coupled, and ESD (static) protected. High-quality components, including the important digital-to-analog converters (DAC), are used to provide low-distortion, low-noise, and sonically excellent performance. Robust circuitry provides protection from damage should a moderate DC voltage be accidentally connected, something especially useful in broadcast applications. The analog outputs are compatible with virtually all balanced and unbalanced loads with an impedance of 2 k ohms or greater.

Audio Input and Output Monitoring

A flexible, easy-to-use monitor section offers users the ability to listen to and visually observe the level of the audio signals that are associated with the eight mic/line input channels and the eight analog output channels. A mode configuration choice allows monitoring of either a single audio channel or a pair of audio channels. This can be valuable when monitoring monaural or stereo (dual-channel) signals. Using a ¼-inch 3-conductor jack, located on the front panel, a 2-channel output supports the connection of a pair of stereo headphones. A rotary control allows the level of the headphone output to be adjusted.

For application flexibility, a 2-channel line-level analog monitor output can also be created. The analog outputs selected for this function would be connected to inputs on amplified loudspeakers or a power amplifier associated with monitor loudspeakers. In this way, the audio signals that are selected for the headphone output will also be used by the designated analog output channels. A configuration choice allows the selected audio sources to be either pre (before) or post (after) the rotary level control.

The front-panel OLED display provides "bar graph" signal level metering. Depending on how the monitor section is being used, one, two, or even eight channels of level can be simultaneously displayed.

Simple Installation

The Model 5518A uses standard connectors to allow fast and convenient interconnections. 3-conductor female XLR connectors, a 25-pin female D-sub-miniature connector, and a 3-conductor ¼-inch jack are used to interface with the mic/line input, analog output, and headphone output audio signals. The unit connects to local area networks (LANs) using three

RJ45 connectors. Multiple LEDs on the unit's back panel display the status of the network connections. A detachable power cord can be used to connect a source of mains power. A DC power source would connect using a 4-pin XLR connector. The lightweight aluminum enclosure mounts in one space (1U) of a standard 19-inch rack enclosure.

Operating Power

The Model 5518A allows an AC mains source of 100-240 V, 50/60 Hz to be connected by way of a standard detachable mains power cord. It can also be DC powered using a 10-16-volt source that is connected via a broadcast-standard 4-pin XLR connector. If both AC and DC power sources are connected, the unit will be powered by the AC mains supply. Only if the AC mains source fails will a load be placed on the DC source. This allows a source of DC, such as a battery pack, to serve in a backup capacity. With this arrangement, normal operation can continue even if AC mains power is lost.

Future Capabilities and Firmware Updating

The Model 5518A was designed so that its capabilities can be easily updated and enhanced in the future. A USB host connector, located on the unit's back panel, allows the main MCU, secondary MCU, and FPGA (programmable-logic) firmware (embedded software) to be updated using a USB flash drive. A Merging Technologies ZMAN module is used to implement the Model 5518A's ST 2110 functionality. The module's firmware can be updated using a web browser connected to the Ethernet interface utilized for ST 2110 control use. All software files and configuration parameters are stored in non-volatile memory.

Installation

In this section, the Model 5518A Mic/Line interface will be mounted in one space (1U) of an equipment rack. Ethernet network connections will be made using RJ45 jacks. Eight microphone- or line-level analog signal sources can be connected. If desired, eight analog audio output signals can be interconnected. AC mains and/or DC power will be connected.

Up to three Gigabit Ethernet data connections will be made to the Model 5518A using standard RJ45

patch cables. Eight 3-pin female XLR connectors are used to interface with the mic/line input channels. Connections to the analog output channels will be made using one 25-pin D-subminiature connector. AC mains power can be connected to the Model 5518A by means of a detachable cord set that is compatible with the unit's 3-pin IEC 320 C14 inlet connector. Some applications may warrant connection to a source of nominal 12 volts DC which can be made by way of a 4-pin XLR connector. The DC source can be used to power the Model 5518A or it can serve as a backup power source should AC mains be connected.

What's Included

The shipping carton contains a Model 5518A Mic/Line Interface and instructions on how to obtain an electronic copy of this guide. Also included in the shipping carton is a North-American-standard AC mains cord. For destinations outside of North America the local reseller or distributor should provide an appropriate AC mains cord.

Mounting the Model 5518A

The Model 5518A Mic/Line interface requires one space (1U) in a standard 19-inch (48.3 cm) equipment rack. Secure the Model 5518A into the equipment rack using two mounting screws per side. As the Model 5518A does not contain a fan or other noise-producing sources it can be located where microphones or other "on air" audio sources will be present. However, keeping the unit away from large sources of electrical noise or significant RF (radio-frequency) fields is probably a good idea. Microphone signals are typically quite small in amplitude and, as such, microphone cables and related circuitry can be susceptible to picking up undesirable signals.

The unit can be located within a room or other structure where audio monitoring is going to take place. Selecting a location that is convenient for making connections to the mic/line input connectors on the front panel may be paramount. In addition, it might be important for personnel to be able to access the front panel's buttons and indicators, allowing easy selection of the Model 5518A's operating parameters, as well as being able to use the headphone monitoring capability. Of secondary importance but still something to be considered would be having access to the unit's back panel. This contains the

Ethernet interfaces, analog audio outputs, and power connectors.

Ethernet Connections

The Model 5518A provides three Gigabit Ethernet (GigE) interfaces for flexibility and compatibility with many ST 2110 and management networking implementations. Two interfaces are provided for interconnection with one or two local area networks (LANs) associated with ST 2110 audio-over-Ethernet networking schemes. One jack is labeled PRI+CTRL (Primary and Control) and is used for both ST 2110 audio and ST 2110 control (monitoring, configuration, and firmware updating). Another jack, labeled SEC, is provided for use by the Secondary ST 2110 audio interface. A third Ethernet interface, labeled MGMT, is dedicated to accessing the Model 5518A's management resources. An internal web server function supports the Model 5518A's Management interface's webpages. These webpages are used for remote configuration, monitoring, and maintenance of Model 5518A operation. The Management interface is also used by the factory at the time of Model 5518A manufacture.

By providing three Ethernet interfaces, the Model 5518A allows support for facilities that utilize independent networks for ST 2110 audio transport and equipment management. In this way, "production" networks that support transport of audio signals by way of a single LAN (for ST 2110 audio) or two LANs (for ST 2110 audio with Redundant Streams operation) can be separate from an engineering network that is used by technical personnel for configuring and maintaining a facility or "plant."

Connections to the three Ethernet interfaces are made by way of standard RJ45 jacks that are

located on the back of the Model 5518A's enclosure. The Ethernet interfaces support auto MDI/MDI-X so that crossover cables are not required.

Twisted-pair (UTC) Ethernet has a 100-meter (325-foot) interconnection cable limitation. This can be overcome by using a fiber-optic interconnection between the Model 5518A and the Ethernet switch or switches in the one or more associated local-area-networks (LANs). This can be easily accomplished using copper-to-fiber-optic media converter units. Commonly available, models are available that will support single- or multi-mode fiber optic cable.

ST 2110 Ethernet Connections

The Model 5518A requires at least one 1000BASE-T Gigabit Ethernet (GigE) connection for ST 2110 operation and configuration. It should be connected to the PRI+CTRL RJ45 jack. A second 1000BASE-T GigE connection can be made to the SEC (Secondary) RJ45 jack if Redundant Streams (ST 2022-7) is desired. This connection would typically be provided by a second physical network. It's also possible that separate VLANs will be created and utilized. Whatever the network arrangement, it's important to note that 100BASE-TX (100 Mb/s) or 10BASE-T (10 Mb/s) Ethernet connections are not sufficient.

Management Ethernet Connection

An Ethernet signal is required to be connected to the Model 5518A's MGMT jack whenever Model 5518A configuration and management needs to be performed. It's recommended that a 1000BASE-T Gigabit Ethernet (GigE) connection be made but a 100BASE-TX (100 Mb/s) or even a 10BASE-T (10 Mb/s) connection is sufficient. (GigE will provide the best performance and it's assumed that all contemporary applications will support it.) The Management interface can share connectivity with the network that is being used by the unit's PRI+CTRL (ST 2110 Primary and Control) network connection. In this case, a separate physical connection would still be required. This connection can be part of the same LAN that is used for ST 2110 audio, or be a member of a VLAN that has been configured for management purchases. It can also be connected to a separate LAN that is designated for monitoring and configuration.

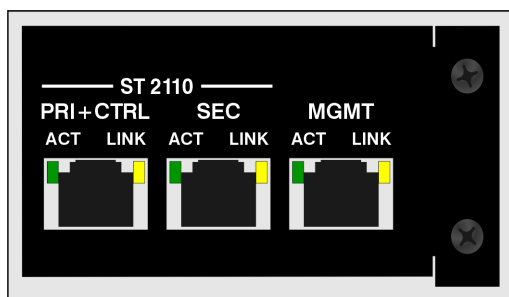

Figure 3. Detail of Model 5518A back panel showing the Ethernet interface's RJ45 jacks

Mic/Line Inputs

The Model 5518A provides eight analog inputs that are intended for connection to microphone or line-level audio signal sources. It's expected that in most applications, the connections to the mic/line inputs will be on a temporary basis, varying “day-to-day” as applications change. As such, in many cases permanent wiring to the eight mic/line inputs is not expected to be made. The 3-pin female XLR connectors, located on the Model 5518A's front panel, do not include the traditional latches that would “lock” the mating connectors to them. This was specifically implemented as a feature, allowing mating connectors to automatically release in the presence of significant force. This makes changing input source cables easy and minimizes the chance of damage to the connectors on the Model 5518A or the mating connector should a cable be accidentally grabbed, pulled, or snagged.

Prepare the 3-pin male XLR mating connectors such that pin 2 carries signal high (+), pin 3 carries signal low (–), and pin 1 is common/shield. It's also highly probable that unbalanced sources will interface correctly with the mic/line inputs. With an unbalanced source, begin by connecting signal high (+) to pin 2 and signal low/shield (–) to both pins 1 and 3. If this provides a “clean” signal interconnection then all is well. However, if this results in hum or noise on the mic/line input, try connecting signal high (+) to pin 2 and signal low/shield (–) only to pin 3; leave pin 1 unconnected (“floating”).

Analog Outputs

The Model 5518A uses one female 25-pin D-subminiature (DB-25F) connector to interface with its eight line-level analog outputs. The connector, located

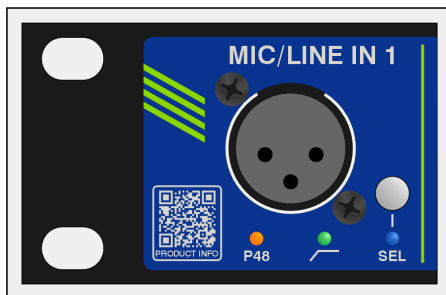

Figure 4. Detail of Model 5518A front panel showing mic/line inputs (typical of eight)

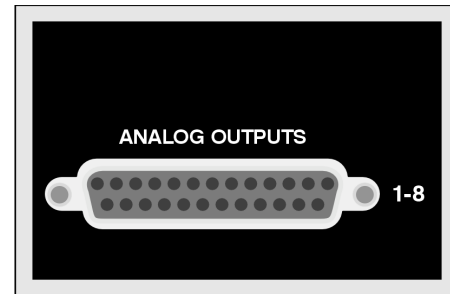

Figure 5. Detail of Model 5518A back panel showing analog outputs

on the unit's back panel, is labeled Analog Outputs. Refer to Appendix A for details on the exact pinout of this D-sub connector.

The wiring scheme used by the D-subminiature connector complies with AES59-2012, as made popular by TASCAM. A wiring assembly prepared for use with the Model 5518A's analog output channels should be identical to that of a TASCAM-type output assembly. Note that unlike a TASCAM-type assembly, the Model 5518A's D-sub connector uses “locking” screws with 4-40 UNC threads.

The analog outputs are electronically balanced and will perform optimally when driving loads of 2 k (2000) ohms or greater. In most applications, 3-pin male XLR connectors will be used to interface with balanced inputs on the associated devices. In this case, a Model 5518A analog output channel's + terminal would go to pin 2 of the XLR, the – terminal to XLR pin 3, and the shield terminal to XLR pin 1. Balanced connection of the analog output channels is the preferred connection method but unbalanced operation does not pose a problem. To connect to an unbalanced input, connect the + terminal as signal high, and only the Model 5518A's shield terminal as the signal low/shield. Leave the – terminal unconnected. For correct unbalanced operation it is important not to connect the – terminal and shield together.

A level trim configuration selection in one of the Model 5518A's management webpages allows adjustment of the signal level of each analog output channel in 0.1-dB steps over a –20.0 to +20.0 dB range. This will help to ensure that the analog output channels will be compatible with audio signals and equipment that have a wide range of nominal levels.

Headphone Output

The Model 5518A provides a stereo (2-channel) analog headphone output which is accessible on the front panel by way of a standard ¼-inch 3-conductor (stereo) tip-ring-sleeve type jack. As would be expected, when the monitor section is selected for stereo operation the headphone output jack has left channel on its tip lead and right channel on its ring lead. When selected for monaural operation, the same channel will be presented to both the tip and ring leads. In both cases, channel common will be on the sleeve lead. The audio source or sources for the headphone output circuitry are selected using the unit's monitor section. A rotary control, also located on the front panel, adjusts the level of headphone output.

The headphone output is suitable not just for connection to a pair of stereo headphones. The audio quality is excellent and there's no reason why it can't be used as an analog unbalanced line-level stereo (2-channel) output. It's recommended that for applications of this type, loads of 2 k ohms or greater be utilized. Prepare an interface cable such that the tip lead of the mating ¼-inch 3-conductor phone plug serves as signal high (+) for the left channel, the ring lead of the plug serves as the signal high (+) for the right channel, and the sleeve lead of the plug serves as signal low (-) for both the left and right channels. One or more of the analog line output channels can also be utilized for monitor output functions. Configuration choices allow them to take on a pre- or post-level control action.



Figure 6. Detail of Model 5518A front panel showing headphone output

Connecting Power

The Model 5518A requires a source of AC mains or nominal 12 volts DC for operation. Either source can be connected with the same result. Both can be simultaneously connected if a redundant (backup) power scheme is desired.

Connecting AC Mains Power

The Model 5518A can operate directly from an AC mains power source of 100 to 240 volts, 50/60 Hz, 20 watts maximum. As a "universal mains input" device there are no switches to set or jumpers to install. A 3-pin IEC 320 C14 inlet connector on the back panel mates with a detachable mains cord set.

All units are supplied from the factory with an AC mains cord that has a North-American (NEMA 5-15L) standard plug on one end and an IEC 320 C13 connector on the other end. Units intended for use in other destinations require that an appropriate mains cord be obtained. The wire colors in the mains cord should conform to the internationally recognized color code and be terminated accordingly:

<u>Connection</u>	<u>Wire Color</u>
Neutral (N)	Light Blue
Line (L)	Brown
Earth/Ground (E)	Green/Yellow

Because the Model 5518A does not contain a power on/off switch it will begin operation as soon as AC mains power is connected.

Safety Warning: The Model 5518A does not contain an AC mains disconnect switch. As such, the plug of the AC mains cord will serve as the disconnection device. Safety considerations require that the plug and associated inlet be easily accessible to allow rapid disconnection of AC mains power should it prove necessary.

Connecting DC Power

The Model 5518A can also operate from a source of 10 to 16 volts DC. The current required from a 12 volts DC source is 1.5 ampere maximum. (1.6 ampere maximum with a 10 volts DC source.) A 4-pin male XLR connector, located on the unit's back panel, is used to connect the source of DC. Prepare a mating connector (female) so that pin 1 is DC- and pin 4

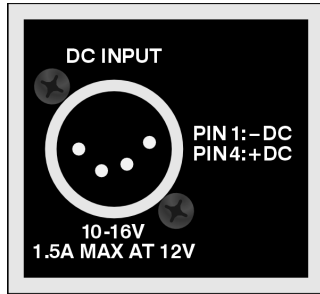

Figure 7. Detail of Model 5518A back panel showing DC input

is DC+. Pins 2 and 3 are not used and should remain unconnected. This type of connector and pinout have become a broadcast DC power standard and should be familiar to many technical personnel. Because the Model 5518A contains no power on/off switch it will begin operation as soon as a DC power source is connected.

As previously mentioned, both an AC mains source and a DC power source can be connected at the same time. If this is the implementation, then the AC mains source will always power the Model 5518A with the DC source serving as a “hot standby.” Only if the AC source fails will the unit draw significant power from the DC source. This will occur automatically with no interruption of Model 5518A operation. In this “standby” mode (when an AC mains source is connected), the Model 5518A will draw less than 120 microamperes (uA) from a connected 12 volts DC source.

ST 2110 Configuration

The Model 5518A's ST 2110 interface is implemented by way of a ZMAN module from Merging Technologies of Switzerland. The ZMAN module is installed in the Model 5518A's DFB II card and is accessed using the ST 2110 PRI+CTRL Ethernet interface which is located on the unit's back panel. A standard web browser running on a personal computer communicates with the ZMAN module utilizing web pages that are provided by ZMAN's web server capability.

To access the webpages is simple. Begin by identifying the PRI+CTRL interface's IP address using the front-panel menu system. On the web browser's command line enter the IP address followed by **/advanced**. As an example, if the IP address of the PRI+CTRL interface is 192.168.1.169 then one

would enter **192.168.1.169/advanced** to access the webpages.

Once the correct address and suffix have been submitted by way of the web browser, the ZMAN module will provide a webpage. This page will have approximately ten tabs that allow many ZMAN features to be displayed and often configured. Refer to Appendix E for a representative view of the Advanced ZMAN General Settings Screen.

Clocking selections can be found by accessing the PTP tab. The Session Sources tab will allow the Model 5518A's ST 2110 sender (output) channels to be displayed and configured. The Session Sinks tab will allow the Model 5518A's receiver (input) channels to be displayed and configured. Also provided is a tab for NMOS configuration.

For an overview of how to configure the Model 5518A's ST 2110 capabilities, refer to the short video that was created by Studio Technologies' personnel for the similar Model 5682 ST 2110 to Dante Bridge product. A link to the Quick Start Guide video can be found in the Model 5682 product page on the Studio Technologies' website (studio-tech.com) under the Documentation, Videos section.

Model 5518A Configuration

Many of the Model 5518A's operating parameters can be configured using the webpages that are provided by way of the Model 5518A's Management Ethernet interface. A standard web browser is all that is required to utilize the menu webpages. Of course, the device hosting the web browser must be part of the same network that includes the Model 5518A's Management Ethernet interface. The Management interface's network configuration can be revised using one of the webpages or by way of the front-panel menus.

Management IP Address

With the Model 5518A powered and operational, and a network connection made to the Management interface, a connection to the web server can typically be established. How the Management Ethernet interface obtains its IP address will depend on a configuration setting. The default configuration

method is automatic such that from the factory the Model 5518A's Management interface will first try to obtain an IP address using DHCP. If that is not successful, an IP address will be assigned using the link-local protocol. (A link-local-obtained IP address will be in the format of 169.254.x.x.) It's also possible that the Model 5518A may have been configured to use a manual (fixed or static) IP address. The Model 5518A's management webpages can be used to review or make changes to the IP address and related parameters. Alternately, the front-panel display and associated pushbutton switches can be utilized.

It should be simple to identify the active management IP address. Press the front-panel down button four times to view the menu that shows the current management IP address. To minimize the chance of screen damage ("burn in"), the unit includes a screen-saver function. It will automatically invoke two minutes after the last press of a front-panel button. When active, it will cause a continuous sequence of two pages to show on the front panel. Both will show the Studio Technologies logo, but one reverses the graphics bits from black to white and vice versa. Pressing the down button four times, even when the screen saver is active, will cause the current management IP address screen to show.

Accessing the Management Webpages

To access the Model 5518A's home page, type the Model 5518A's management IP address into the browser's search bar. (It's possible that some browsers may require the text **http://** followed by the IP address.)

Home and Login Menus

Once the Home page is displayed, a number of Model 5518A operating parameters will be presented. This includes the ST 2110 device name, the unit's overall status, and the link, IP, and PTP status of the two Ethernet interfaces that are provided for ST 2110 operation. In addition, access to the configuration menus is also possible. Click on the link labeled Login, on the page's right side, and it will lead to the Login menu webpage. The entry of a valid user name and password is now required. This is not a sophisticated security implementation. It is intended to keep "honest" people from making unauthorized or unintentional changes to the configuration of the Model 5518A.

User Name: Enter the Model 5518A's user name into this field. It is case sensitive. The default user name is **guest**. If the default user name and default password are active, the default user name will show in this field.

Password: Enter the Model 5518A's password into this field. It is case sensitive. The default password is **guest**. If the default user name and default password are active, the default password will show in this field.

Login Button: Click on the Login button to submit the entered user name and password. If the correct entries have been made, access to the configuration

menu webpage will show. If an incorrect user name and/or password is entered a login failed message will be shown.

Configuration Menu Choices

Once a correct user name and password combination have been submitted the Home menu webpage will again show. In addition to the displaying the previously mentioned operating parameters, tabs for accessing six other menus allow many Model 5518A configuration choices to be shown and, in many cases, revised.

Mic/Line Inputs Menu

The Model 5518A provides eight analog input channels which are compatible with line- or microphone-level signals. Three configuration choices are available for each input channel.

Channel	P48	HPF	Gain (dB)
1	<input type="checkbox"/>	<input type="checkbox"/>	0
2	<input type="checkbox"/>	<input type="checkbox"/>	0
3	<input type="checkbox"/>	<input type="checkbox"/>	0
4	<input type="checkbox"/>	<input type="checkbox"/>	0
5	<input type="checkbox"/>	<input type="checkbox"/>	0
6	<input type="checkbox"/>	<input type="checkbox"/>	0
7	<input type="checkbox"/>	<input type="checkbox"/>	0
8	<input type="checkbox"/>	<input type="checkbox"/>	0

ST 2110 Sender Source Mic/Line Inputs Submit

P48 Phantom Power

Choices are: *Off* (check box not enabled) and *On* (check box enabled)

Each of the eight mic/line input channels allows a source of P48 phantom power to be enabled as desired. Typically used as a power source for a condenser (capacitor) microphone, the state of these functions can be controlled by way of this webpage, the STcontroller application, or using a pushbutton switch that's located on the Model 5518A's front panel. The current state of each P48 function will show on the webpage or by way of an orange LED located the unit's front panel. The LED will light whenever P48 is active for that channel. By design, P48 can be active at whatever gain has been selected for the mic/line input, including 0 dB (line level).

HPF (High-Pass Filter)

Choices are: *Off* (check box not enabled) and *On* (check box enabled)

Each of the eight mic/line input channels allows a HPF (high-pass filter) function to be enabled. This is typically used to minimize the impact of unwanted low-frequency energy that can be picked up by a connected microphone. The on or off state of the HPF functions can be controlled by way of the webpage or using the pushbutton button switches on unit's front panel. The current state of the HPF functions will be shown on the webpage and by way of green LEDs located on the unit's front panel. An LED will light when the HPF function is active for that channel. By design, the HPF function can be active at whatever gain has been selected for the mic/line input, including 0 dB (line level).

Gain Adjustment

Choices are: 0 dB and 10-60 dB in 1-dB steps

The circuitry associated with the Model 5518A's eight mic/line input channels can have their gain individually adjusted (trimmed). The channels are labeled 1 through 8 and their gain can be set for 0 dB, and then 10 through 60 dB in 1-dB steps.

Setting a channel for 0 dB of gain would be appropriate for interfacing with line-level signals. In this situation, connecting an analog signal with a precise level of +4 dBu would result in an output level of –20 dBFS on the associated ST 2110 sender (output) channel. Connecting a dynamic microphone might require setting the gain to 40 dB, 50 dB, or even greater. A condenser microphone with a “hot” output might require less gain for correct operation. Refer to the Operation section for additional details on how to use the level meter functions to optimize the gain settings.

Submit: A Submit button is located at the bottom of the configuration choice area. To save changes made to any of the P48, HPF, or Gain fields requires that the Submit button be pressed.

ST 2110 Sender Source

Choices are: *Mic/Line Inputs*, *ST 2110 Receivers*, and *1 kHz Tone*

There are eight ST 2110 sender (output) channels associated with the Model 5518A. The signal sources for these sender channels, as a group, can be selected from among three choices. Selecting *Mic/Line Inputs* is the usual setting. This will cause the Model 5518A to always use mic/line inputs 1-8 as the sources for ST 2110 sender channels 1-8. These are connected one-to-one, with mic/line input 1 routed to sender channel 1, mic/line input 2 routed to sender channel 2, and so forth through channel 8.

Selecting *ST 2110 Receivers* causes the Model 5518A's eight ST 2110 receiver (input) channels to be used as the signal sources for the eight ST 2110 sender (output) channels. The channels are mapped one-to-one, with receiver channel 1 routed to sender channel 1, receiver channel 2 routed to sender channel 2, etc. This setting can be considered as an ST 2110 loopback function that would typically only be used for test purposes.

Selecting *1 kHz Tone* causes a precise 1000 Hz (1 kHz) sine-wave tone with a level of –20 dBFS to be present on all eight of the Model 5518A's ST 2110 sender (output) channels. This is an excellent method of providing a known signal source on all eight of the sender channels and should prove useful in test and troubleshooting situations. The Model 5518A does

not allow the frequency and/or overall output level of the tones to be adjusted.

Submit: A Submit button is located below the source selection box. To save the selected choice requires that the Submit button be pressed.

Analog Outputs Menu

The Model 5518A provides eight analog output channels. Each channel can have its source selected and its output gain adjusted (“trimmed”).

Channel	Source	Gain (±dB)
1	ST 2110 Receiver 1	0
2	ST 2110 Receiver 2	0
3	ST 2110 Receiver 3	0
4	ST 2110 Receiver 4	0
5	ST 2110 Receiver 5	0
6	ST 2110 Receiver 6	0
7	ST 2110 Receiver 7	0
8	ST 2110 Receiver 8	0

Source

Choices are: *Mic/Line Input X*, *ST 2110 Receiver X*, *1 kHz Tone*, *Monitor Y Pre-Fader*, and *Monitor Y Post-Fader*. (X is the channel number. Y is 1 for the odd analog output channels and 2 for the even analog output channels.)

The Model 5518A is unique in that each of the eight analog outputs can have its source selected from among five choices. Selecting *Mic/Line Input* as the source for an analog line output will create what an audio console would consider to be a direct out function. The output of the preamplifier associated with a mic/line input circuit will be the source for the analog output. While probably not the typical setting, it can be useful for special applications including during installation, deployment, and testing. Selecting *ST 2110 Receiver* is the usual setting, configuring a Model 5518A to use an ST 2110 receiver (input) channel as the signal source for the analog output channel. Selecting *1 kHz Tone* makes a 1000 Hz (1 kHz) sine-wave tone with a level of +4 dBu nominal be present on the analog output channel. This is an excellent method of providing a known signal on the analog output channel and is expected to be useful

for test situations. The Model 5518A does not allow the frequency of the tone to be adjusted.

Selecting *Monitor Pre-Fader* allows an analog output to be used as part of a monitoring function. The channel selected for monitoring using the front-panel pushbutton switches will be routed to the analog output channel and its level won't be impacted by the rotary level control on the front panel. It will be electrically “pre” (before) the headphone level control (“fader”). Selecting *Monitor Post-Fader* will use the same source but the output level will be controlled by the front-panel rotary level control. Having the choice of pre- or post-fader allows connection to a variety of monitor systems, including amplified loudspeakers, that may, or may not, include integrated level controls.

Gain Adjustment

The circuitry associated with the Model 5518A's eight analog output channels can have their gain individually adjusted (trimmed). The channels are labeled 1 through 8 and the gain range is –20.0 to +20.0 in 0.1-dB steps. These gain trim functions can be used to allow the relative level of each analog output channel to be matched. They can also be used to adjust the analog output levels such that their nominal level

is something different than the unit's default nominal level of +4 dBu. (The default nominal level is achieved with a gain level setting of 0 dB.) The level adjustment settings will apply to each analog output channel, no matter what signal source has been selected. This means that the level trim settings will apply to their associated analog outputs whether the mic/line input, ST 2110 receiver (input), 1 kHz tone, or monitor pre- or post-fader is serving as the channel's audio source.

Submit: A Submit button is located below the configuration fields. To save changes made to any of the sixteen fields requires that the Submit button be pressed.

Monitor Menu

The Model 5518A provides an audio monitor section, allowing a user to confirm performance of the eight mic/line input and eight ST 2110 receiver (input) channels. The monitor webpage allows the overall mode and signal source or sources to be selected for monitoring. Five pushbutton switches and a level control on the front panel of the unit are also used by the monitor function. A headphone output jack is located on the front panel and, if desired, one or more of the analog output channels can be configured for use as monitor outputs.

The screenshot shows the 'Monitor' menu of the Model 5518A Mic/Line Interface. The page title is 'Model 5518A Mic/Line Interface' and the device ID is 'ST-M5518A-LAB Identify Device'. The navigation menu includes 'Home', 'Mic/Line Inputs', 'Analog Outputs', 'Monitor' (selected), 'Network', 'Access', and 'System'. There is a 'Log Out' button. The 'Mode' section has a dropdown menu set to 'Stereo' and a 'Submit' button. The 'Source' section has a dropdown menu set to 'ST 2110 Receivers'. The 'Channel' section has a dropdown menu set to '3/4' and a 'Submit' button. The footer is 'Studio Technologies, Inc.'

Mode

Choices are *Mono* and *Stereo*

The overall operation of the Model 5518A's monitor section can be configured for monaural or stereo. The choice of operating mode can be made using a selection on the webpage or using a button press on the front-panel menu. When selected for *Mono* a signal is routed to both the left and right monitor output channels. When selected for *Stereo* a signal on an odd channel (1, 3, 5, or 7) is routed to the left monitor output channel, while a signal on an even channel (2, 4, 6, or 8) is routed to the right channel.

Submit: A Submit button is located below the selection box. To save the selected choice requires that the Submit button be pressed.

Source

Choices are *Mic/Line Inputs* and *ST 2110 Receivers*

When *Mic/Line Inputs* is selected the monitor sources are the outputs of the preamplifier circuits associated with the eight mic/line inputs. When *ST 2110 Receivers* is selected the monitor sources are the signals associated with the eight ST 2110 receiver (input) channels.

Channel(s)

When the overall monitor mode is selected to be *Mono*, the Channel choices are 1, 2, 3, 4, 5, 6, 7, and 8. This makes sense as only one signal is to be monitored at any one time.

When the overall monitor mode is elected to be *Stereo*, the Channel choices are 1/2, 3/4, 5/6, and 7/8. These are, as expected, pairs of signals.

Submit: A Submit button is located below the two selection boxes. To save the selected Source and Channel choices requires that the Submit button be pressed.

Network Menu

Model 5518A
Mic/Line Interface

ST-M5518A-LAB
Identify Device

Home Mic/Line Inputs Analog Outputs Monitor **Network** Access System Log Out

Reload

Current Network Information	Primary + Control	Secondary	Management
Link Status	Up	Starting...	Up
IP Address	0.0.0.0	0.0.0.0	192.168.1.242
Subnet Mask	255.255.255.0	255.255.0.0	255.255.255.0
Gateway	---	---	192.168.1.1
MAC Address	30-D6-59-01-BE-62	30-D6-59-81-BE-62	00-04-22-F5-00-94

Management Interface Configuration

IP Configuration

Manual IP Address

Manual Subnet Mask

Manual Gateway

Studio Technologies, Inc.

Current Network Information

Each Model 5518A has three Ethernet interfaces: Primary + Control, Secondary, and Management. Three columns, each consisting of five fields, provides important network information about each interface.

Link Status: These are display-only fields that show the link status associated with each Ethernet interface. The displayed text will either be *Starting*, *Down*, or *Up*. *Starting* indicates that the ZMAN module (used to implement the ST 2110 interface) is in the process of booting (starting) up. *Down* indicates that a connection to an Ethernet interface has not been established. *Up* indicates that a connection to an Ethernet interface has been established.

IP Address: These are display-only fields that show the IP address associated with each Ethernet interface. Shown in dot-decimal notation.

Subnet Mask: These are display-only fields that show the subnet mask value associated with each Ethernet interface. Shown in dot-decimal notation.

Gateway: These are display-only fields that show the gateway address associated with each Ethernet interface. Shown in dot-decimal notation.

MAC Address: These are display-only fields that show the MAC (media access control) address associated with each Ethernet interface. These are unique hardware identification numbers that are assigned to each specific Model 5518A Ethernet interface.

Management Interface Configuration

The method used by the Management Ethernet interface to obtain its IP address can be selected. Specific values can be entered should the manual IP address selection method be chosen.

IP Configuration: This is a configurable field with two choices: *Automatic* and *Manual*. It impacts how the Model 5518A obtains the IP address that is used for accessing the Model 5518A's management web server and associated menu webpages. This setting has no impact on how the Model 5518A obtains its Primary + Control and Secondary IP addresses that are associated with the ST 2110-related Ethernet interfaces.

Selecting *Automatic* will cause the Model 5518A to use DHCP or IPv4 link-local to establish the IP address for accessing the Model 5518A's Management interface. With this setting, upon establishing a link

to the Model 5518A's management RJ45 jack the DHCP protocol will request an IP address and related parameters. If obtaining an IP address by way of a DHCP server is not successful then the IPv4 link-local protocol will be used. If the established IP address has the format of 169.254.x.x then it was assigned using the IPv4 link-local.

Even if the management IP address was established using link-local the DHCP protocol will stay active. The Model 5518A's firmware will continue to check for the presence of a DHCP server. If one becomes available then an IP address will be requested and, when obtained, will automatically be used, replacing the IP address that was previously established by link-local.

The *Manual* setting allows the desired IP address and related parameters for the Management interface to be manually entered. This can be useful when a fixed addressing scheme has been established. In this way, a "static" IP address can be entered along with the other important network parameters.

When selected for *Automatic* the fields for Manual IP Address, Manual Subnet Mask, and Manual Gateway will be "grayed out" (will have a gray background) to indicate that their values cannot be manually changed. In this condition, they are display-only. Changing between Automatic and Manual and vice-versa will not impact the values stored in the Manual IP Address, Manual Subnet Mask, and Manual Gateway fields. Note that the front-panel display and associated pushbutton switches can also be used to revise the Model 5518A's management IP address configuration.

Note that to minimize the chance of losing access to the Model 5518A's management web server, restoring the unit's factory defaults will not change the currently selected management IP configuration choice.

Manual IP Address: This field is grayed out and will not show any text when the IP configuration mode is selected for *Automatic*. When the IP address configuration is selected for *Manual*, this field will show the IP address that is stored within the Model 5518A. This is the IP address that is currently being used, or will be used at the time of the next Management Ethernet interface reboot. This IP address allows

access to the Model 5518A's management web server and associated menu webpages. It has nothing to do with the IP addresses associated with the ST 2110 Ethernet interfaces.

The manual IP address can be modified as desired to meet the requirements of the application. After entering an IP address using the standard dot-decimal notation format (four octets separated by dots) the Submit button must be pressed for the changes to be stored. Restoring the Model 5518A to its default values will not change the stored IP address. A system reboot is required for a revised manual IP address to be utilized. Note that the front-panel display and associated pushbutton switches can also be used to revise the Model 5518A's manual IP address (although it is less convenient).

Manual Subnet Mask: This field is grayed out when the IP configuration mode is selected for *Automatic*. This field will be display-only in this instance and will show an IPv4 subnet mask value in dot-decimal notation (four octets separated by dots) if the current IP address and related network parameters were obtained by way of DHCP. This is the subnet mask that is being used by the unit's management web server. If the IP address configuration mode is selected for *Automatic* and the current IP address was obtained by way of link-local then a subnet mask address of 255.255.0.0 will be shown in this field.

When the IP configuration model is selected for *Manual* the manual subnet mask field will not be grayed out. In this situation, the stored subnet mask will be shown and can be modified as desired to meet the requirements of the application. The value shown is the subnet mask that is currently in use, or will be used at the time of the next Management Ethernet interface reboot. After entering the desired subnet mask value using the standard dot-decimal notation format (four octets separated by dots) the Submit button must be pressed for the change to be stored. A system reboot is required for the revised subnet mask value to be utilized. Note that the front-panel display and associated pushbutton switches can also be used to revise the Model 5518A's management subnet mask. Restoring the Model 5518A to its default values will not change the stored manual subnet mask value.

Manual Gateway: This field is grayed out when the IP configuration mode is selected for *Automatic*. This field will be display-only in this instance and will show an IPv4 gateway IP address in dot-decimal notation (four octets separated by dots) if the current IP address and related network parameters were obtained by way of DHCP. This is the gateway IP address that is being used by the Model 5518A's management web server.

If the IP configuration mode is selected for *Automatic* and the current IP address was obtained by way of link-local no gateway IP address will be shown in this field. This is because no gateway IP address is associated with link-local.

When the IP configuration mode is selected for *Manual* the gateway IP address field will not be grayed out. In this situation, the stored gateway IP address will be shown and can be modified as desired to meet the requirements of the application.

The shown value is the gateway IP address that is currently in use, or will be used at the time of the next Management Ethernet interface reboot. After entering a gateway IP address using the standard dot-decimal notation format (four octets separated by dots) the Submit button must be pressed for a change to be stored. A system reboot is required for the revised gateway IP address to be utilized. Restoring the Model 5518A's default values will not change the stored gateway IP address value.

Submit: A Submit button is located near the bottom of the Network menu webpage. To save any changes made to Network configuration fields requires that the saved Submit button be pressed.

Access Menu

Front Panel Control

Choices are: *View/Edit*, *View Only*

A graphics display and five associated pushbutton switches are located on the Model 5518A's front panel. This field allows the action of the pushbutton switches to be selected between two choices. When *View/Edit* is selected the buttons can be used to select what is shown on the display as well as allowing several configuration choices to be changed. When *View Only* is selected the pushbutton switches will only allow selection of what information is to be shown. The buttons will not allow any configuration changes to be made. They will, however, always be available for use by the audio monitor section. Refer to Appendix C for a detailed list of the front-panel menus.

Submit: A Submit button is located below the Front Panel Control selection field. This button must be pressed to save a change made to the Front Panel Control configuration.

Management Login Credentials

As a security method, a user name and password must be entered before the configuration webpages can be accessed. These values can be changed as desired.

The Model 5518A's access security method is in no way rigorous. The user name and password are sent to and received from the Model 5518A as plain text. They are also stored within the Model 5518A as plain text. There is no security method or encryption associated with these fields. Anyone "snooping" on the LAN that is transporting Model 5518A management data will see all values in plain text! The user name and password values are intended simply to provide a means of keeping "friendly" or "honest" users from easily changing the configuration of a Model 5518A. If unauthorized access is of concern, it's recommended that an Ethernet connection to the Model 5518A's management RJ45 jack not be present except when access by authorized personnel is desired.

The default user name is **guest** and the default password is **guest**. These are case sensitive. If neither of these default values are changed then they will show in the User Name and Password entry fields on the Login menu webpage. If the default user name and/or default password are changed then neither the user name nor the password will show upon accessing the Login menu webpage.

User Name: In this field, a revised user name can be entered. It must be a minimum of five characters, a maximum of 15 characters, and is case sensitive. All 95 of the printable ASCII characters can be used. These include upper and lower alphabetic characters, numbers, and standard punctuation marks.

New Password: In this field, a revised password can be entered. The password is a minimum of five characters, a maximum of 15 characters, and is case sensitive. All 95 of the printable ASCII characters can be used. These include upper and lower alphabetic characters, numbers, and standard punctuation marks.

Confirm New Password: For a new password to be considered valid it must also be entered in this field.

Submit: A Submit button is located below the field for Confirm New Password. To save a change made to the User Name field and/or New Password field requires that the Submit button be pressed.

System Menu

Model 5518A
Mic/Line Interface

ST-M5518A-LAB
Identify Device

Home Mic/Line Inputs Analog Outputs Monitor Network Access **System** Log Out

Serial Number 00148
Device Name ST-M5518A-LAB

Version Information

	Version	Date
Main MCU Firmware	1.00	30 Jan 2025
Secondary MCU Firmware	2.00	23 Aug 2023
FPGA Firmware	1.01	30 Aug 2021
ST 2110 Firmware	1.6.5b59902	---

Restore Default Configuration

Operational Settings
Management Interface and Access Settings
Submit

System Reboot
Reboot

[Studio Technologies, Inc.](#)

Serial Number: This is a display-only field that shows the Model 5518A's hardware serial number. A 5-digit number, it is assigned at the factory and cannot be changed.

Device Name: This is a display-only field that shows the name assigned to the ST 2110 interface.

Version Information

Seven display-only fields show information about the firmware (embedded software) that is currently loaded and operating in this specific Model 5518A.

Main MCU Firmware: Two display-only fields show the version number and release date of the Model 5518A's Main MCU firmware. This is the firmware that runs in the Model 5518A's microcontroller (MCU) integrated circuit. This firmware can be updated using a USB flash drive. Details are provided in the Technical Notes section.

Secondary MCU Firmware: Two display-only fields show the version number and release date of the Model 5518A's Secondary MCU firmware. This is the firmware that runs in the Model 5518A's motherboard microcontroller (MCU) integrated circuit. This firmware can be updated using a USB flash drive. Details are provided in the Technical Notes section.

FPGA Firmware: Two display-only fields show the version number and release date of the firmware used by the Model 5518A's programmable logic (FPGA) device. This is the firmware that runs in the Model 5518A's high-speed logic device. This firmware can be updated using a USB flash drive. Details are provided in the Technical Notes section.

ST 2110 Firmware: One display-only field shows the version number of the firmware associated with the ZMAN module that the Model 5518A utilizes for ST 2110 interconnectivity. (There is no associated date.). This version number is assigned

by Merging Technologies and can't be changed by Studio Technologies. The firmware for the Model 5518A's ST 2110 interface can be updated by way of an Ethernet connection made to the Primary + Control Ethernet interface. Refer to the Technical Note section for details.

Restore Default Configuration: There are two check boxes associated with the restore default configuration function. Either or both can be selected prior to pressing the associated Submit button. Enabling the Operational Settings check box allows all the Model 5518A's configuration settings to be restored to their factory default values with the exception of the Management interface and user access settings. The configuration values associated with these two functions will not change. Enabling the Management Interface and Access Setting check box allows the Model 5518A's factory default configuration settings for the IP Address Configuration method, Manual IP Address, Subnet Mask, Gateway IP Address, User Name, and Password to be returned to their factory default values. Refer to Appendix F for a list of these values. After selecting either or both of the check boxes and pressing the Submit button a confirmation message will appear.

System Reboot: A check box and a reboot button are provided in the System Reboot section of this menu page. This function is provided to allow a user to force the Model 5518A to restart operation. Any changes made to the network configuration and/or user name and password settings will be in effect. Once the Reboot check box has been enabled, pressing the Reboot button will cause the Model 5518A to halt current operation and restart ("boot") the unit.

Webpage Inactivity Timer/ Automatic Log Out

Once a web browser has successfully logged into the Model 5518A's menu system an inactivity timer will become active. If no configuration setting has been changed, a webpage refreshed, or a webpage newly accessed for 15 minutes, the user will automatically be logged out. Returning to the menu pages will require the login procedure to be successfully completed.

Menu Text and Links

The following paragraphs provide details on some of the links, buttons, and text that are presented on the Model 5518A's webpages.

Company Name Link: On the bottom of each webpage is a link with the title Studio Technologies, Inc. Clicking on this link will cause the browser to open the home webpage of the Studio Technologies website.

ST 2110 Name: In the upper-right corner of each Model 5518A webpage is the ST 2110 interface's name. This name should be unique to each device in a deployment and would be used as part of the identification and channel routing process. The name can be changed from within the configuration webpages provided by ST 2110 interface.

Identify Device Button: In the upper-right corner of most Model 5518A webpages is a button called Identify Device. Clicking on it will cause a unique lighting sequence to occur using the eight blue SEL LEDs that are located on the Model 5518A's front panel. The identify device command will help users ensure that the web server on the desired Model 5518A is being accessed.

Log Out Button: A button called Log Out is located in the upper-right of each Configuration menu webpage. It will cause the Model 5518A's web server to end its active session and log out the user. To again access the menu webpages will require that a user provide a valid user name and password.

Operation

Now that the Model 5518A is installed and configured it's ready for use. There are a number of nuances in the unit's operation. This may make it useful for technical personnel to spend some time reviewing this section.

Upon application of AC mains or DC power, the Model 5518A will go through a power-up sequence. The LED associated with the USB receptacle on the unit's back panel will briefly light green to indicate that it is functioning. The LEDs associated with the Model 5518A's three Ethernet jacks will flash several times as part of the associated Ethernet interface integrated circuit's power-up action. The 25 LEDs

on the unit's front panel will light in a confirmation sequence. After that has completed the display will then enter its "screen saver" mode which shows the Studio Technologies logo. The operating condition of the Model 5518A as it was at the time of the previous power down will be restored. All configuration settings will be restored and normal unit operation will begin. The pushbutton switches associated with the display functions will become active.

Back Panel RJ45 LED Indicators

On the Model 5518A's back panel there are three RJ45 jacks that are provided for interfacing with the unit's three Gigabit Ethernet (GigE) interfaces. Two of the jacks are designated for ST 2110 audio and configuration use and the third for management functions. The three RJ45 jacks are labeled PRI+CTRL, SEC, and MGMT. Associated with each jack are two LEDs. One LED is labeled LINK and lights orange when a GigE connection has been established with that specific jack. The LINK LED will not light if a 100 Mb/s or 10 Mb/s Ethernet connection has been made. It will also not light if an Ethernet connection has not been made. The second LED, labeled ACT, will flash green to indicate data activity, responding to Ethernet traffic traveling to and from that specific jack.

Mic/Line Input Configuration

Each of the eight mic/line inputs can be individually configured for its P48 microphone phantom power on/off status, its HPF (high-pass filter) function on/off status, and the gain of its associated preamplifier circuit. One display is "shared" by all eight mic/line input channels (along with the monitor section). It indicates the status of the P48 phantom power function, the status of the HPF function, and provides a level meter function associated with the output of the microphone preamplifier. The display also allows configuration of the microphone preamplifier gain value. Pushbutton switches adjacent to the display allow the gain of the preamplifier to be adjusted. Buttons are also provided to control the status of the P48 and HPF functions.

Three LED indicators and a pushbutton switch are associated with each of the eight mic/line input sections on the front panel. Two LED indicators will light to indicate the status of the P48 and HPF functions. The pushbutton switches, labeled SEL, each have an associated LED. The switch is used to select that

specific mic/line input section for assignment to the display and its associated buttons.

Momentarily pressing (tapping) an SEL button will cause its associated LED to light and the display will indicate information about that specific mic/line input section. The pushbutton switches associated with the display can then be used to configure the selected mic/line input section's P48 function, HPF function, and preamplifier gain. Momentarily pressing (tapping) the P48 and HPF buttons change their status. The P48 and HPF LEDs in the selected mic/line input section will change state in response to a change in the function.

With the preamplifier gain set for anything in the range of 10 to 59 dB, the up arrow button will increase the gain in 1-dB steps. When the preamplifier gain is set for anything in the range of 11 to 60 dB, the down arrow button will decrease the preamplifier gain in 1-dB steps. The right arrow button will increase the preamplifier gain in 5-dB steps. (With an exception being if the preamplifier gain is set within the range of +11 to +14 dB, then pressing the right button will cause the gain to move to +15 dB.) The left arrow button will decrease the gain in 5-dB steps. (With an exception being if the preamplifier gain is within the range of +11 to +14 dB, then pressing the left button will cause the gain to move to +10 dB.) If the preamplifier gain is set for 10 dB any gain down command will move the gain to 0 dB. If the preamplifier gain is set to 0 dB, then any gain up command will move the gain to 10 dB.

Whenever an input section has a change made to its P48, HPF, or preamplifier gain setting the LED associated with that input select switch will flash three times. As discussed previously, if an input section is currently selected the LED associated with that switch will light. Pressing the select pushbutton switch again will "release" that mic/line input section, turning off the LED and returning the display and associated pushbutton switches to perform their default actions.

Audio Monitoring

A monitor section is provided on the far-right side of the Model 5518A's front panel. This allows audio monitoring of the unit's eight mic/line input channels and eight ST 2110 receiver (input) channels. A headphone jack, push-in/push-out level control, pushbutton



Figure 8. Detail of Model 5518A front panel showing monitor section

switch, and an LED are associated with the headphone monitor function. The monitor output is in the form of a ¼-inch 3-conductor jack that is compatible with standard stereo headphones (tip left, ring right, and sleeve common). The rotary level control is used to adjust the level of the stereo (2-channel) signal that is sent to the headphone output jack. The pushbutton switch, labeled SEL, is used to select the headphone monitor section for configuration. The display and up and down arrow buttons are used to select the specific audio signal or signals to be monitored.

When the switch associated with the headphone monitoring section is momentarily pressed (tapped), the LED associated with it will light. The display will then indicate the current status of the monitor section. It will show either one number or a pair of numbers to indicate which channel or channels are currently being monitored. If a single audio channel is being monitored, it will be sent to both the left and right channels of the headphone output. If two audio channels are being monitored, the first channel of the “pair” is sent to the left headphone output channel. The second channel of the “pair” is sent to the right headphone output channel. To switch (toggle) between monitoring a single channel and two channels, or vice-versa, simultaneously press and hold both the up and down arrow buttons.

Depending on the configuration of the monitor section, the up arrow and down arrow pushbutton switches will select either one signal or two signals. The signal or signals selected for monitoring will be saved. In the event of a power down/power up situation the Model 5518A will return to the same monitor state. Pressing the select button when it is active will “release” the monitor section, disabling the LED

and returning the display and associated pushbutton switches to perform their default actions.

Technical Notes

Management IP Address

A Management Ethernet interface is associated with the Model 5518A's overall configuration. Using an RJ45 jack, this interface, labeled MGMT, is provided only for factory use. By default, the network parameters for this interface are set to be obtained automatically. In this way, it will attempt to automatically obtain an IP address and associated settings using DHCP. If a DHCP server is not detected, an IP address will automatically be assigned using the link-local protocol in the IPv4 range of 169.254.x.x. The IP address can also be manually configured.

Model 5518A Firmware Update

The major functions implemented in the Model 5518A utilizes an interface circuit board which is named the DFB II card. It is linked together inside the unit with a circuit card referred to as the motherboard. The DFB II card supports the ST 2110 interface as well as the front-panel menu system and the web-based management menu system.

Four firmware files are utilized in the Model 5518A. They can all be individually field-updated. One firmware file, called the main MCU firmware, is used by the DFB II card's microcontroller integrated circuit. A second firmware file, called the FPGA firmware, is used by the DFB II card's field-programmable-gate-array (FPGA) integrated circuit. A third file used by the DFB II card supports the ZMAN module which implements the Model 5518A's ST 2110 interface. The fourth file, the secondary MCU, is used by the mother board's microcontroller circuit.



Figure 9. Detail of Model 5518A back panel showing firmware update USB receptacle

The main MCU, secondary MCU, and FPGA firmware files are updated using a USB flash drive that is plugged into the USB type A receptacle labeled Firmware Update. The firmware used by the DFB II card for the ZMAN module is updated using a personal computer that is connected, via Ethernet, using the ST 2110's PRI+CTRL RJ45 jack. It's not possible to directly use a USB flash drive for this update process.

It's possible that updated versions of the firmware (embedded software) files that are utilized by the Model 5518A will be released to add features or correct issues. Refer to the Studio Technologies' website for the latest firmware files. Details on the actual update process will be covered in the following paragraphs.

DFB II Card Main MCU, Secondary MCU, and FPGA Firmware Update

The DFB II card has the ability to load three of its four firmware files into non-volatile memory by way of a standard USB flash drive. A USB host function provides access to update its firmware by way of a USB type A receptacle. This receptacle, labeled Firmware Update, is located on the unit's back panel. The names of the three files are **M5518AvXrXX.stm** for the main MCU firmware, **M5518AsecvXrXX.sts** for the secondary MCU firmware, and **M5518AvXrXX.stf** for the FPGA firmware, where Xs are decimal digits that represent the version number.

The update process begins by preparing a USB flash drive. The flash drive doesn't have to be empty (blank) but must be in the personal-computer-standard FAT32 format. The firmware files can be automatically loaded at essentially the same time. On the flash drive's root folder, save the desired new firmware file(s), ensuring that the required name or names are specified. For the main MCU firmware the file name must be **M5518AvXrXX.stm**. For the secondary MCU firmware the file name must be **M5518AsecvXrXX.sts**. And for the FPGA firmware the file name must be **M5518AvXrXX.stf**.

Studio Technologies will supply each firmware file inside a .zip archive file. While the firmware file inside of the .zip file will adhere to the required naming convention, the name of the .zip file itself will be slightly different. For example, a file named **M5518Av1r01MCU.zip** would indicate that version

1.01 of the main MCU firmware (**M5518Av1r01.stm**) is contained within this .zip file.

Once the USB flash drive has been prepared it can be used to update the DFB II card. To begin the update process, insert the prepared flash drive into the USB receptacle that is labeled Firmware Update, then the Model 5518A must be powered off and again powered on. At this point, the file(s) will be automatically loaded. Once completed, the USB flash drive can then be removed. The precise steps required will be highlighted in the next paragraphs.

To install one, two, or all three of the firmware files in the DFB II card follow these steps:

1. Remove power from the Model 5518A. This will entail either removing the AC mains power connector or removing the external source of 12 volts DC. (Both must be disconnected if dual powering has been implemented.)
2. Locate the USB type A receptacle on the Model 5518A's back panel that is labeled Firmware Update. Directly adjacent to this USB receptacle is a small hole that provides visual access to a green LED indicator.
3. Insert the prepared USB flash drive into the USB type A receptacle.
4. Apply power to the Model 5518A. Power can be provided by connecting AC mains or a source of 12 volts DC.
5. After a few seconds, the DFB II card will run a "boot loader" program that will automatically load and save the new firmware files that are present on the USB flash drive. The time required for the update process can range from approximately 15 seconds to approximately 45 seconds, depending on which of the files are going to be updated. While the files are being loaded, the green LED, located adjacent to the USB receptacle, will flash slowly. Once the entire loading process has completed, the DFB II card will restart using the newly saved firmware.
6. At this time, the DFB II card should be functioning with the newly loaded firmware and the USB flash drive can be removed. To be conservative, remove the power source first, then remove the USB flash drive.

7. Apply power to the Model 5518A. Power can be provided by connecting AC mains or a source of 12 volts DC. At this point, it's a good idea to confirm that the desired firmware versions have been loaded into the Model 5518A. This will help to ensure that the unit is operating as expected. To observe the version numbers of the loaded firmware, simply view the unit's front-panel display pages.

Note that upon power being applied to the Model 5518A, if a connected USB flash drive doesn't have one, two, or three files with the required names in its root folder no harm will occur. Upon power up the green LED, located adjacent to the USB receptacle, will flash on and off rapidly for a few seconds to indicate that a valid file has not been found. After this warning, operation using the unit's existing firmware will begin.

DFB II Card ST 2110 Firmware Update

As previously discussed, the Model 5518A implements ST 2110 connectivity using Merging Technologies' ZMAN module which is installed in the DFB II card. The Model 5518A's front-panel display can be used to view the version number of the firmware that resides in the ZMAN module. A webpage provided by the ZMAN module can also be used to determine the version of the firmware. The latest Model 5518A ST 2110 firmware file, with an extension of .zoem, is always available on the Studio Technologies' website.

The firmware (embedded software) residing in the ZMAN module is updated by way of an Ethernet connection that links the DFB II card to a personal computer. Webpages that are "served" by the ZMAN module are accessed by the personal computer's browser and are used to execute the update process. The following sections detail the process involved in updating the ZMAN firmware.

1. Begin the update process by downloading the latest Model 5518A ZMAN firmware from the Studio Technologies' website (studio-tech.com). The file on the website will be in the form of a .zip file that contains both the actual ZMAN firmware file (.zoem extension) and a release notes file (.txt extension). The downloaded .zip file should

be stored on the personal computer's disk and the actual firmware file should be extracted and stored in a location (disk folder) that allows easy access. The downloaded .zip and extracted firmware files can also be stored on a USB flash drive if the files need to be moved from a computer outside of a firewall to one that has access to the Model 5518A. The firmware will be in the format of **M5518AvXrX.zoem** where the Xs represent the actual version number. As an example, a file with a name of **M5518Av1r9.zoem** would support a Model 5518A with a version number of 1.9.

2. Use the personal computer to access the Model 5518A's PRI+CRTL interface. The IP address of this interface can be viewed from the front-panel menu. It's part of the screen saver routine as well as being accessible using the pushbutton switches. Refer to Appendix C for a detailed view of the menu system.
3. Using a standard web browser running on the personal computer, enter the ST 2110 PRI+CRTL interface's IP address into the command line. This will cause a webpage to be "served" by the ZMAN module. We refer to this as the "landing page," an example of which is shown in Appendix D, Figure 1.
4. Using the personal computer's mouse, select the **Info** choice on the bottom of the landing page. This will take the browser to the info page, an example of which is shown in Appendix D, Figure 2. The info page will display several general ZMAN parameters, including the temperature, serial number, and firmware version. It will also provide two choices, including one that says **Firmware Update**.
5. Use the personal computer's mouse to select the firmware update command. The file selection webpage will appear. Refer to Appendix D, Figure 3 for an example of this webpage.
6. Using the personal computer's mouse, select the **Select File** button and choose the desired ZMAN file (.zoem) that was previously downloaded and stored on the personal computer. Once a file has been selected, a slightly changed download page will again display. Refer to Appendix D, Figure 4 for an example of what you might observe.

7. Using the personal computer's mouse, select the **Update** button and the updating process will begin. The process will begin by uploading the selected file from the person computer to the ZMAN module. The actual upload process will take approximately 30 seconds after which the menu will display the text **Uploading: 100%**. Refer to Appendix D, Figure 5 for an example of the webpage. This is part of the process so just observe the webpage at this stage.
8. The process will automatically continue, preparing the now-uploaded file and loading it into the required location on ZMAN's memory. This will take approximately five additional minutes. During this time, please do not disturb the personal computer browser or Model 5518A. Once the update process has completed, a new webpage will display, offering an opportunity to reboot the module. Refer to Appendix D, Figure 6 for an example.
9. On the reboot page, use the personal computer's mouse to click on **Reboot Device** to begin the ZMAN module's reboot process. Refer to Appendix D, Figure 7 for an example of the webpage.
10. Rebooting will take about one and a half minutes. When completed, the Model 5518A and associated ZMAN module will be operating under the new firmware. The info webpage will again appear. Refer to Appendix D, Figure 8 for an example of this webpage.
11. Observe the info webpage and confirm that the ZMAN module is running the desired firmware version. If it is not, review the update steps and execute the update process again.

Restoring Default Values

A command in the System webpage provided by the Model 5518A's web server allows most of the configuration settings to be restored to their factory default values. This can be useful but must be used with caution. Any customization made to the Model 5518A's configuration will be lost. This can be offset in a positive way by returning the Model 5518A to a known configuration, a point that might aid in troubleshooting an issue. Refer to Appendix F for a list of the default values.

Lost User Name and/or Password

As is covered in detail in other sections, gaining access to the Model 5518A's configuration menu webpages requires entering the correct user name and password. If the default entries, both of which are **guest**, are stored for use they will show on the Login menu webpage. Pressing the Login button on that webpage will access the Home configuration webpage. If either or both the user name and the password have been configured to be something other than **guest** (the default), nothing will show in the fields associated with the Login menu webpage.

If knowledge of the stored user name and/or password is "lost," the Model 5518A includes a "back door" to allow access. As a security measure, physical access to the unit is required to utilize that access method; there is no means to access the unit via an Ethernet interface without knowledge of the user name and password. The exact process of accessing the Model 5518A's configuration webpages without knowledge of the user name and/or password is detailed in Appendix G.

Specifications

Network Audio Technology – ST 2110:

Type: SMPTE ST 2110-10:2017 and ST 2110-30:2017

Supports Conformance Levels:

A: 48 kHz streams with 1-8 audio channels at packet times of 1 ms

B: 48 kHz streams with 1-8 audio channels at packet times of 125 us

C: 48 kHz streams with 1-64 audio channels at packet times of 1 ms

AX: 96 kHz streams with 1-4 audio channels at packet times of 1 ms

BX: 96 kHz streams with 1-8 audio channels at packet times of 125 us

CX: 96 kHz streams with 1-32 audio channels at packet times of 125 us

AMWA NMOS Support: IS-04 Discover & Registration (“Discovery”) and IS-05 Device Connection Management (“Routing”)

Redundant Streams: compliant with Level B, SMPTE ST 2022-7:2013 Seamless Protection Switching (8-channel stream at 48 kHz sample rate, packet time 125 us)

Synchronization: per SMPTE ST 2110-10, Precision Time Protocol (PTP) IEEE® 1588-2008 Version 2; supported profile IEEE 1588:2008

Compatibility: JT-NM TR-1001 (System Environment and Device Behavior)

Discovery, Control, and Connection Management: includes web user interface, NMOS, Merging Technologies’ ANEMAN Audio Network Manager, and JSON API,

Audio Performance and Transport: digital

Audio Type: pulse-code modulation (PCM)

Sampling Rate: 48 kHz

Bit Depth: 24

Number of Sender (Output) Channels: 8

Number of Receiver (Input) Channels: 8

Remote Control of Mic/Line Input Parameters:
webpages provided by internal web server

Network Interfaces:

Qty: 3; ST 2110 Primary + Control, ST 2110 Secondary, and Management

Type: 1000BASE-T (Gigabit Ethernet (GigE)) per IEEE 802.3ab

NIC Status LEDs: one link and one activity for each Ethernet interface

Mic/Line Inputs: 8

Compatibility: dynamic, ribbon, or phantom-powered mics; mic/line-level sources

Type: analog, electronically balanced, capacitor coupled

Impedance – Mic Setting: 3.0 k ohms, nominal

Impedance – Line Setting: 6.4 k ohms, nominal

Gain: 0 dB (line), 10-60 dB in 1-dB steps

Maximum Level: +24 dBu, 0 dB gain selected (results in digital output level of 0 dBFS)

EIN: –126 dBu, 22 kHz bandwidth, 49 dB gain, 150 ohms source resistance

Dynamic Range: >117 dB, 0 dB gain, A-weighted

Distortion (THD+N): <0.001% (–101 dB) at –1 dBFS, 40 dB gain, 22 kHz bandwidth

Frequency Response: +0.0/–0.1 dB, 20 Hz to 22 kHz, HPF off

High-Pass Filter (HPF): –6 dB at 75 Hz, 18 dB per octave, on/off selectable per channel

Phantom Power: P48 per IEC 61938:2013 standard, +46 volts DC nominal, on/off selectable per channel

Metering: part of OLED display function

Status LEDs per Input Channel: 3; P48, HPF, and input channel selected

Remote Configuration Capability: preamplifier gain, P48 phantom power on/off status, and high-pass filter (HPF) on/off status (uses webpages accessible by way of Ethernet interface)

Analog Outputs: 8

Type: line-level, electronically balanced, capacitor coupled, intended to drive balanced or unbalanced loads of 2 k ohms or greater

Source Impedance: 200 ohms

Nominal Level: +4 dBu, reference –20 dBFS, adjustable ±20 dB in 1-dB steps

Maximum Level: +24 dBu

Dynamic Range: >119 dB, A-weighted

Distortion (THD+N): 0.001% (–100 dB), reference 1 kHz, measured at +23 dBu output (–1 dBFS input)

Frequency Response: ±0.1 dB, 6 Hz to 20 kHz

Audio Monitoring:

Source: mic/line inputs or analog outputs, selectable as monaural (one channel) or stereo (two channels)

Meter Function: part of OLED display function

Headphone Output:

Type: stereo (dual-channel)

Compatibility: intended for connection to stereo headphones with nominal impedance of 100 ohms or greater

Maximum Output Voltage: 4.9 volts RMS, 1 kHz, 150 ohms load

Frequency Response: +0/-1.4 dB, 20 Hz to 20 kHz

Distortion (THD+N): 0.005%

Dynamic Range: >100 dB

Front-Panel Display: OLED

Software Updating: USB flash drive supports updating of main MCU, secondary MCU, and FPGA firmware (embedded software); webpages via PRI+CRTL interface used to update ZMAN module used for ST 2110

Power Sources:

AC Mains: 100 to 240 V, 50/60 Hz, 20 W maximum

DC: 10 to 16 V, 1.6 A max at 10 V; 1.5 A max at 12 V

Connectors:

Mic/Line Inputs: 3-pin female XLR

Analog Outputs: 25-pin female D-subminiature (DB-25F), AES59-2012 compliant

Ethernet Interfaces: RJ45

Headphone Output: 3-conductor ¼-inch jack

USB: type A receptacle (used only for firmware updates)

AC Mains Input: 3-blade, IEC 320 C14-compatible (mates with IEC 320 C13)

DC Input: 4-pin male XLR (pin 1 negative, pin 4 positive)

Environmental:

Operating Temperature: 0 to 50 degrees C (32 to 122 degrees F)

Storage Temperature: -40 to 70 degrees C (-40 to 158 degrees F)

Humidity: 5 to 95%, non-condensing

Altitude: not characterized

Dimensions – Overall:

19.0 inches wide (48.3 cm)

1.72 inches high (4.4 cm)

7.8 inches deep (19.8 cm); 8.3 inches (21.1 cm) overall

Mounting: one space (1U) in a standard 19-inch rack

Weight: 3.5 pounds (1.6 kg)

Specifications and information contained in this User Guide subject to change without notice.

Appendix A—Connection Pin-Out Chart

Model 5518A Analog Outputs

Connections for Analog Output Channels 1-8

Channel	High (+)	Low (-)	Shield
1	24	12	25
2	10	23	11
3	21	9	22
4	7	20	8
5	18	6	19
6	4	17	5
7	15	3	16
8	1	14	2

Notes:

- 1) Connector type is 25-pin female D-subminiature (DB-25F). Installer must provide male (DB-25M). Connectors use 4-40 UNC threaded inserts for locking with mating plug.
- 2) Wiring schemes follow AES59-2012 convention. Standard TASCAM-type wiring harnesses are typically compatible (locking hardware requires 4-40 UNC screw threads).

Appendix B—Source Selection Overview

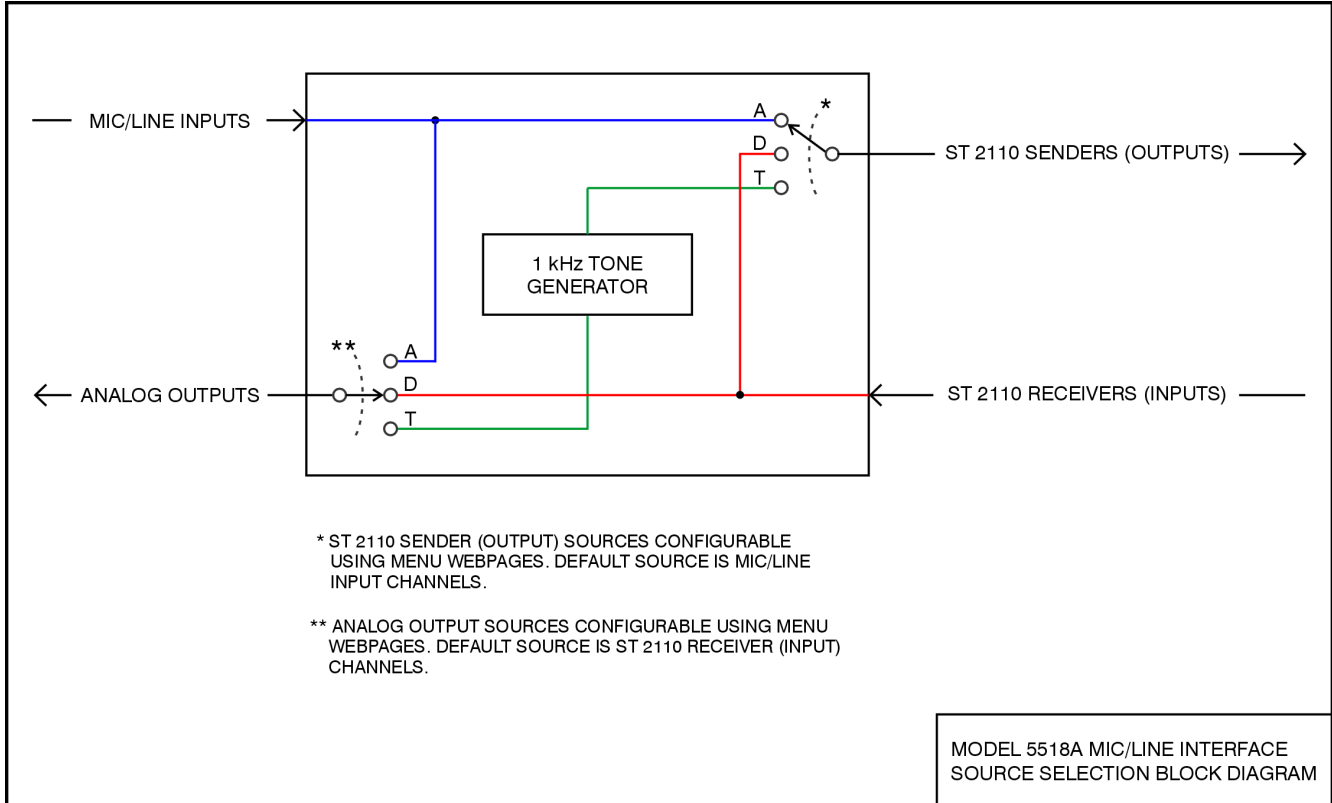

Appendix C—Front-Panel Menu Structure

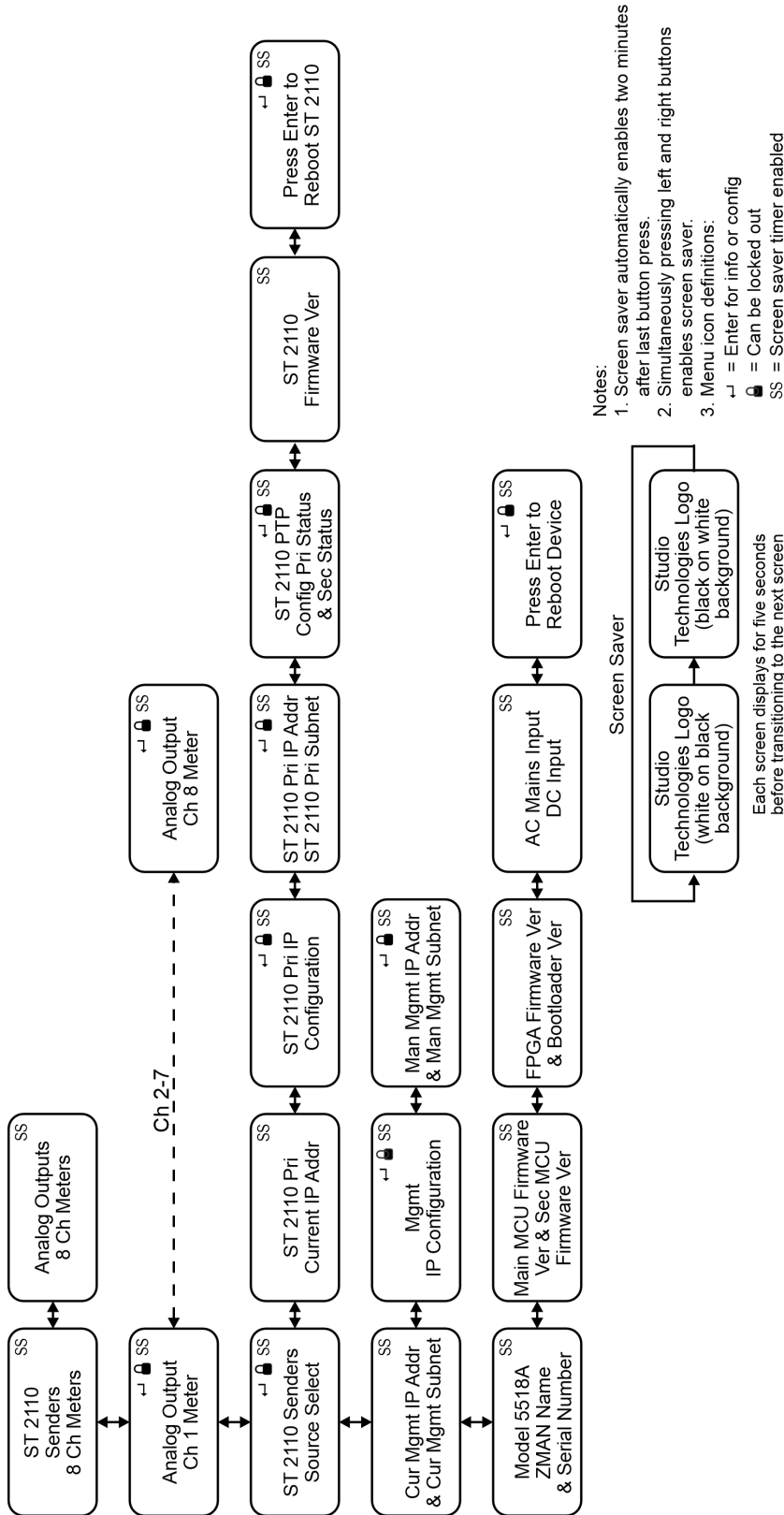

Appendix D–ZMAN Firmware Update Screens

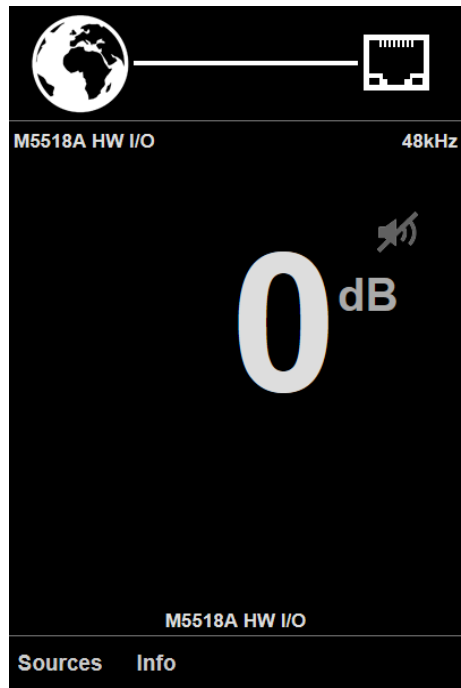

Figure 1.

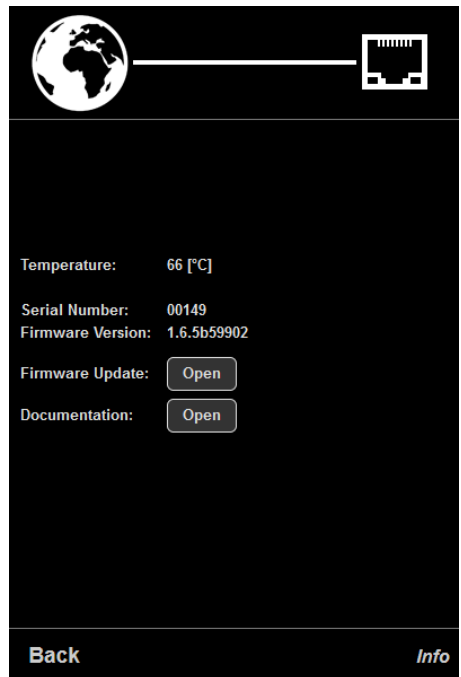

Figure 2.

Appendix D–ZMAN Firmware Update Screens, continued

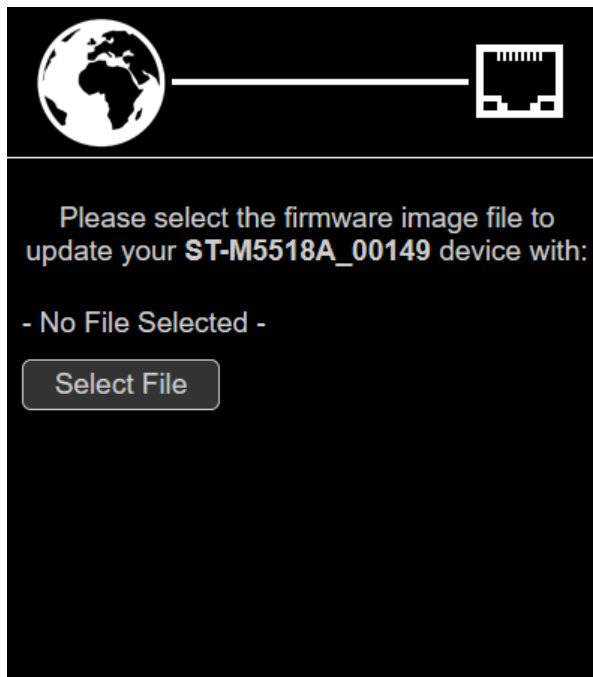

Figure 3.



Figure 4.

Appendix D–ZMAN Firmware Update Screens, continued



Figure 5.

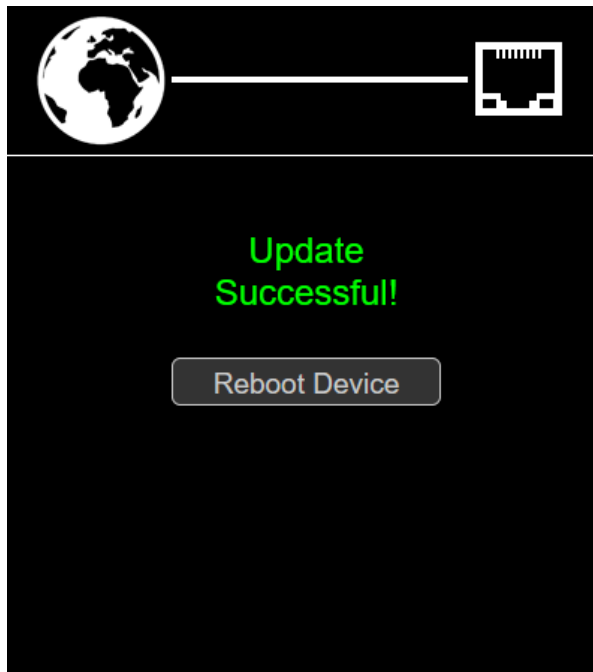

Figure 6.

Appendix D–ZMAN Firmware Update Screens, continued

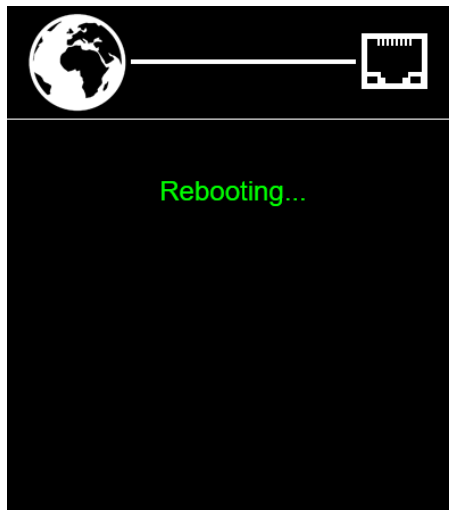

Figure 7.

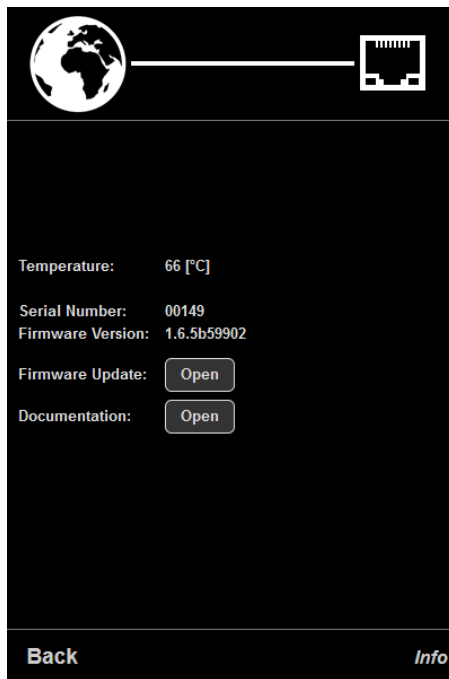

Figure 8.

Appendix E–Advanced ZMAN General Settings Screen

RAVENNA
AES67 *now!*

ST-M5518A_00149.local

Vendor Studio Technologies, Inc.
Product M5518A
Serial 00149
Identify Me

STUDIO TECHNOLOGIES INC.

General settings | PTP | ASIO Clock | Session sources | Session sinks | Ins/Outs | I/O Router | Statistics | NMOS | System

Device Name
ST-M5518A-LAB
This is the unique zeroconf device name. Other devices see this device name.
Location

Audio Configuration
Sample rate: 48 kHz
Frame size (@1FS): 48 smpl AES67(1ms)

Session Sinks Global
Safety Playback Delay (@1FS): 0
SSM (requires IGMP v3)

Network
Multi-Interface mode
Note: must be checked for ST2022-7 support.

Interface 1
Link: Up
Name: Primary + Control
Type: Static
Address: 192.168.1.135
Netmask: 255.255.255.0
Gateway: 192.168.1.1 Use as Primary Gateway
DNS: 192.168.1.178

Interface 2
Link: Down
Name: Secondary
Mode: Media Only

Appendix F—Default Configuration Values

Mic/Line Inputs:

P48: Off
HPF: Off
Gain: 0.0 dB
ST 2110 Sender (Output) Source: Mic/Line Inputs

Analog Outputs:

Source: ST 2110 Receivers (Inputs)
Gain: 0.0 dB

Monitor:

Mode: Stereo
Source: Mic/Line Inputs
Channel: 1/2

Network - Management Interface:

IP Address Configuration: Automatic
Manual IP Address: 192.168.1.18
Subnet Mask: 255.255.255.0
Gateway IP Address: 192.168.1.1

Access:

Front Panel Control: View/Edit
User Name: guest
Password: guest

Appendix G—Accessing the Unit when User Name and/or Password are Not Known

Follow this procedure to access the Configuration menu webpages if the user name and/or password are not known.



1. Remove power from the Model 5518A.
2. Press and hold the left arrow and Enter buttons.
3. While continuing to hold the two buttons apply AC Mains or 12 volts DC power.
4. Continue to hold the two buttons and allow the Model 5518A to start. The Status LEDs on the front panel will first light green then light red in their start-up sequence.
5. Once the Status LEDs have completed their start-up sequence release the two buttons.
6. Use a web browser to access the Model 5518A's Configuration menu webpages. The management port's IP address to use is shown in the current management IP address page on the front-panel display. Pressing the Enter button will cause the current management IP address page to immediately show on the front-panel display.
7. From the Home webpage select the Login menu webpage tab. Leave the user name and password fields empty and click the Log In button. This will allow access to the Configuration menu selections. At this point your web browser should show the Model 5518A's Home webpage.
8. Navigate to the Access menu. From this webpage you will be able to view the stored user name. You will not be able to view the previously saved password. Enter and confirm a new password. Henceforth, to access the Model 5518A's Configuration menu will require the use of the stored user name and password.