

Model 5682 ST 2110 to Dante Bridge Front-Panel Menu Structure

Button-Controlled Menus

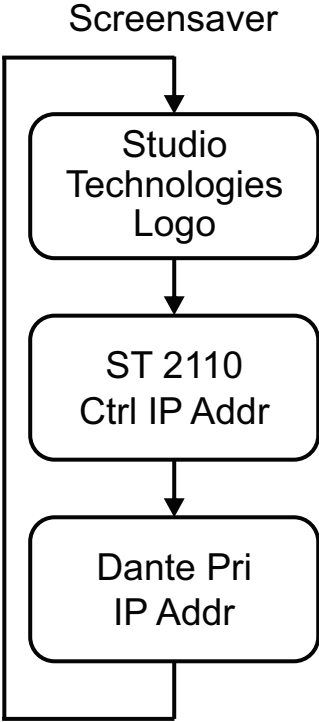

- Notes:
1. Screen saver automatically enables two minutes after last button press.
 2. Simultaneously pressing left and right buttons enables screen saver.
 3. Menu icon definitions:
 ↵ = Enter for info or config
 [] = Value cannot be edited

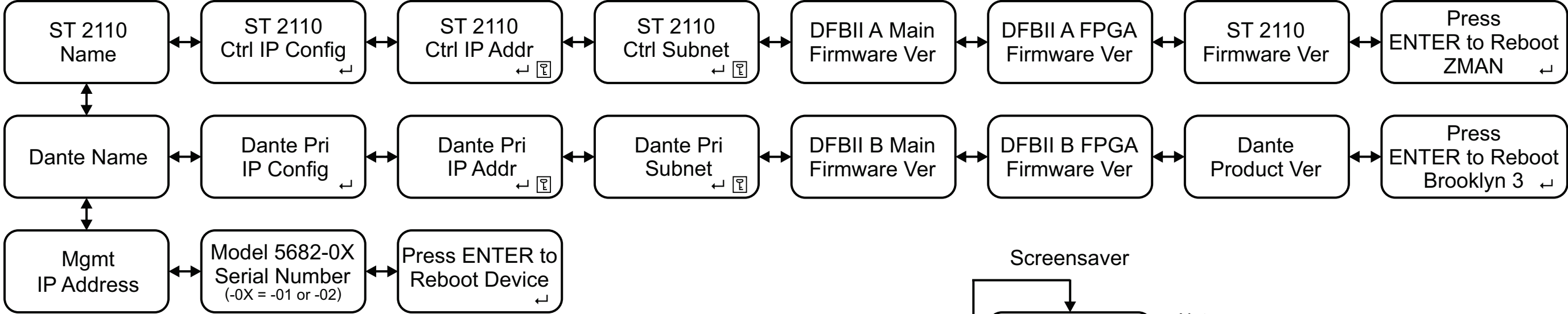

studio-tech.com

50783-0124, Issue 3