



Model 210

Announcer's Console

Configuration Guide

This Configuration Guide is applicable for serial numbers: M210-00415 and later

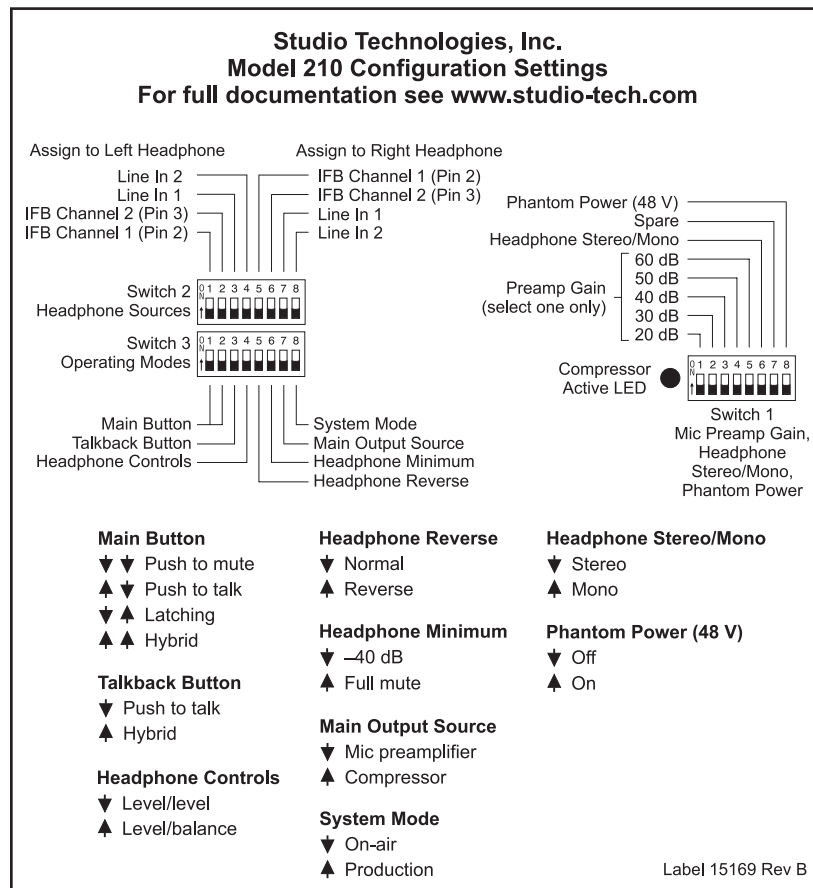

Model 210 configuration settings label as affixed to security plate

Actual size 4.25" x 4.60"

Cut along lines for use as a spare

Model 210 Bottom Panel

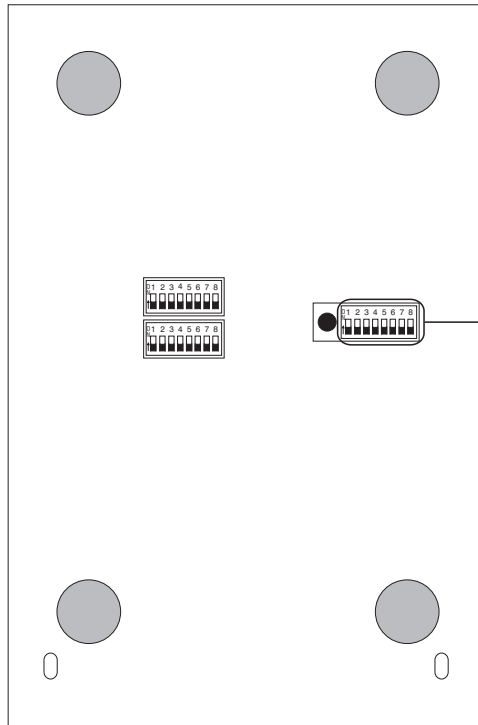

Switch 1 Settings
Detailed Below

SW1-1 through SW1-5 – Mic Preamp Gain



20 dB



30 dB



40 dB



50 dB

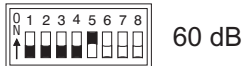

60 dB

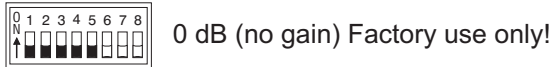

0 dB (no gain) Factory use only!

SW1-6 – Headphone Stereo/Mono



Stereo

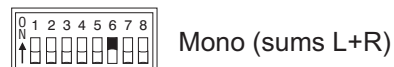

Mono (sums L+R)

SW1-8 – Phantom Power (48 V)



Off



On

SW1-7 – Spare

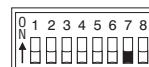

Model 210 Bottom Panel

Switch 2 Settings
Detailed Below

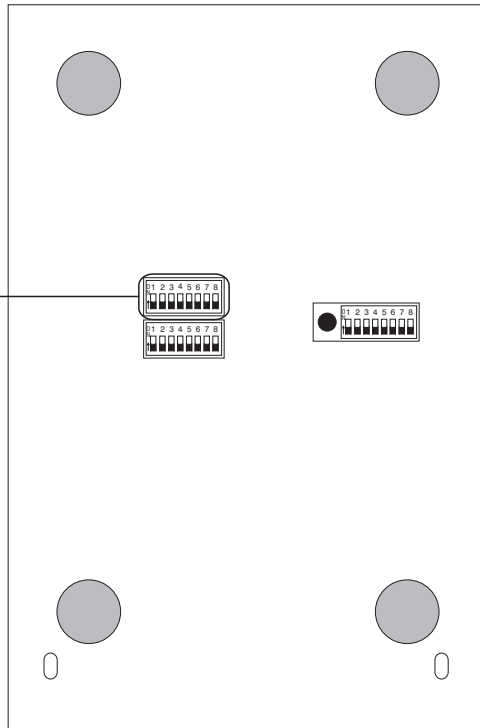

SW2-1 through SW2-4 – Left Channel Headphone Source Selection

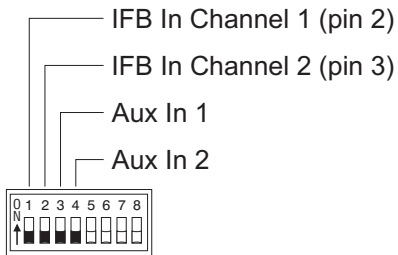

On to enable source; multiple sources will sum

SW2-5 through SW2-8 – Right Channel Headphone Source Selection

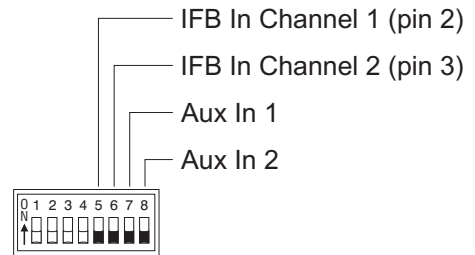

On to enable source; multiple sources will sum

Model 210 Bottom Panel

Switch 3 Settings
Detailed Below

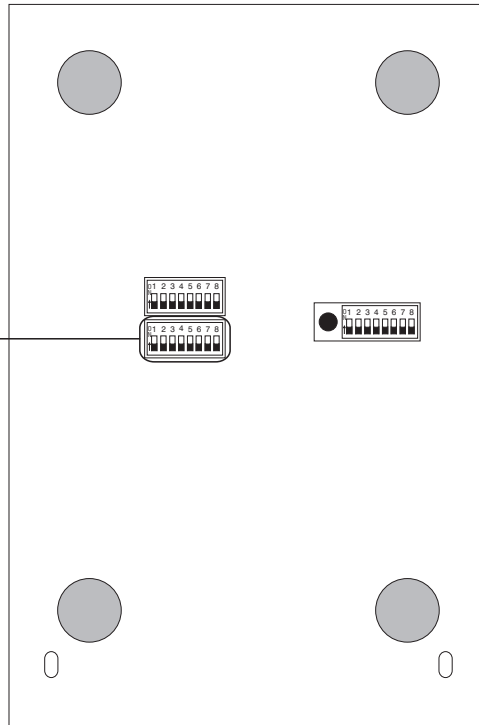

SW3-1 and SW3-2 – Main Button Mode

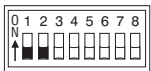

Push to mute (“cough”)

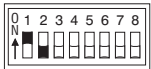

Push to talk

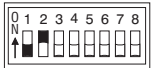

Alternate action (“latching”)

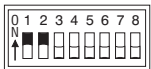

Hybrid (press and hold to enable, tap to latch)

SW3-3 – Talkback Button Mode



Push to talk



Hybrid (press and hold to enable, tap to latch)

SW3-4 – Headphone Control Mode



Dual channel (“level/level”)

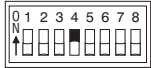

Stereo (“level/balance”)

SW3-5 – Headphone Control Operation



Normal

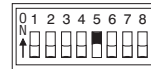

Reverse left/right

SW3-6 – Headphone Output Minimum Level

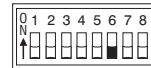

–40 dB

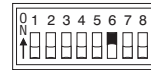

Full mute

SW3-7 – Main Output Source

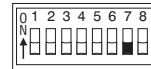

Mic preamplifier

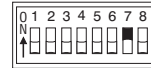

Compressor

SW3-8 – System Mode

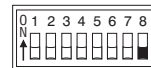

On-air (talkback output status impacts main output status)

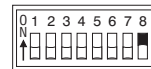

Production (talkback output status does not impact main output status)